

ASM[®] 500 Spray Guns

Models: 288681 and 289316

3600 psi (248 bar, 25 MPa) Maximum Fluid Working Pressure

ALLPRO[®] Manufactured by ASM

Mustang 500 Spray Guns

Models: 289283 and 289284

3600 psi (248 bar, 25 MPa) Maximum Fluid Working Pressure



IMPORTANT SAFETY INSTRUCTIONS. Refer to your sprayer instruction manual for Pressure Relief, priming and spray instructions. Keep these instructions.

- For the application of architectural paints and coatings -

The following Warnings are for the setup, use, grounding, maintenance and repair of this equipment. The exclamation point symbol alerts you to a general warning and hazard symbols refer to procedure-specific risks. Refer back to these Warnings. Additional, product-specific warnings may be found throughout the body of this manual where applicable.

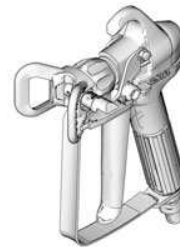

Models 288681 and 289284 ti10348a

312363E



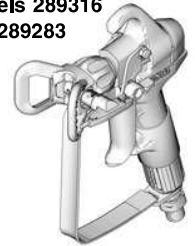

ENG

Models 289316 and 289283





ti10328a



 WARNING	
	<p>SKIN INJECTION HAZARD</p> <p>High-pressure fluid from gun, hose leaks, or ruptured components will pierce skin. This may look like just a cut, but it is a serious injury that can result in amputation. Get immediate surgical treatment.</p> <ul style="list-style-type: none"> • Do not point gun at anyone or at any part of the body. • Do not put your hand over the spray tip. • Do not stop or deflect leaks with your hand, body, glove, or rag. • Do not spray without tip guard and trigger guard installed. • Engage trigger lock when not spraying. • Follow Pressure Relief Procedure in this manual, when you stop spraying and before cleaning, checking, or servicing equipment.
	<p>FIRE AND EXPLOSION HAZARD</p> <p>Flammable fumes, such as solvent and paint fumes, in work area can ignite or explode. To help prevent fire and explosion:</p> <ul style="list-style-type: none"> • Use equipment only in well ventilated area. • Eliminate all ignition sources; such as pilot lights, cigarettes, portable electric lamps, and plastic drop cloths (potential static arc). • Keep work area free of debris, including solvent, rags and gasoline. • Do not plug or unplug power cords or turn power or light switches on or off when flammable fumes are present. • Ground all equipment in the work area. See Grounding instructions. • Use only grounded hoses. • Hold gun firmly to side of grounded pail when triggering into pail. • If there is static sparking or you feel a shock, stop operation immediately. Do not use equipment until you identify and correct the problem. • Keep a working fire extinguisher in the work area.
	<p>TOXIC FLUID OR FUMES HAZARD</p> <p>Toxic fluids or fumes can cause serious injury or death if splashed in the eyes or on skin, inhaled, or swallowed.</p> <ul style="list-style-type: none"> • Read MSDS's to know the specific hazards of the fluids you are using. • Store hazardous fluid in approved containers, and dispose of it according to applicable guidelines. • Always wear impervious gloves when spraying or cleaning equipment.
	<p>PERSONAL PROTECTIVE EQUIPMENT</p> <p>You must wear appropriate protective equipment when operating, servicing, or when in the operating area of the equipment to help protect you from serious injury, including eye injury, inhalation of toxic fumes, burns, and hearing loss. This equipment includes but is not limited to:</p> <ul style="list-style-type: none"> • Protective eyewear • Clothing and respirator as recommended by the fluid and solvent manufacturer • Gloves • Hearing protection



⚠ WARNING

	<p>EQUIPMENT MISUSE HAZARD</p> <p>Misuse can cause death or serious injury.</p> <ul style="list-style-type: none"> Do not operate the unit when fatigued or under the influence of drugs or alcohol. Do not exceed the maximum working pressure or temperature rating of the lowest rated system component. See Technical Data in all equipment manuals. Use fluids and solvents that are compatible with equipment wetted parts. See Technical Data in all equipment manuals. Read fluid and solvent manufacturer's warnings. For complete information about your material, request MSDS forms from distributor or retailer. Check equipment daily. Repair or replace worn or damaged parts immediately with genuine manufacturer's replacement parts only. Do not alter or modify equipment. Use equipment only for its intended purpose. Call your distributor for information. Route hoses and cables away from traffic areas, sharp edges, moving parts, and hot surfaces. Do not kink or over bend hoses or use hoses to pull equipment. Keep children and animals away from work area. Comply with all applicable safety regulations.
	<p>PRESSURIZED ALUMINUM PARTS HAZARD</p> <p>Do not use 1,1,1-trichloroethane, methylene chloride, other halogenated hydrocarbon solvents or fluids containing such solvents in pressurized aluminum equipment. Such use can cause serious chemical reaction and equipment rupture, and result in death, serious injury, and property damage.</p>

Related Manuals

This manual is available in the following languages.

Manual	Language
312364	Spanish
312365	French

Pressure Relief Procedure





Follow this **Pressure Relief Procedure** whenever you are instructed to relieve pressure, stop spraying, check or service equipment, or install or clean spray tip.

- Turn OFF power and turn sprayer pressure control to lowest pressure setting.
- Hold gun against side of flushing pail. Trigger gun into pail to relieve pressure.

If you suspect spray tip or hose is clogged or that pressure has not been fully relieved after following the steps above, VERY SLOWLY loosen tip guard retaining nut or hose end coupling to relieve pressure gradually, then loosen completely. Clear hose or tip obstruction.

Gun Trigger Lock

						
To prevent injury when the gun is not in use, always engage the gun's trigger lock if unit is being shut down or left unattended.						

Trigger Locked (no spray)



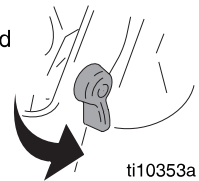

ti10352a

Trigger Unlocked (spray)



ti10353a

Setup

						
Make sure sprayer is turned off and unplugged from power source. Refer to your sprayer instruction manual for priming and spray instructions.						

Connect Gun to Sprayer

- Attach supply hose to sprayer fluid outlet.
- Attach other end of supply hose to gun swivel. Use two wrenches (one on the swivel and one on the hose) to tighten all connections securely.
- Refer to sprayer instruction manual for priming instructions.

Install Tip and Guard on Gun

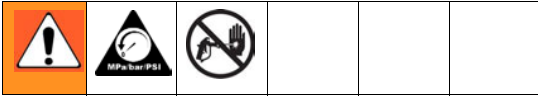

1. **Relieve Pressure.** Engage trigger lock.
2. Using a pencil or similar object, insert seal (16) into back of guard.
3. Install guard (2) over end of gun.
4. Insert tip (15) in guard. Tighten retaining nut.

Operation



Spraying

1. Disengage trigger lock.
2. Be sure the arrow shaped tip faces forward (spray).
3. Hold gun perpendicular and approximately 12 in. (304 mm) from surface. Move gun first, then pull gun trigger to spray a test pattern.
4. Slowly increase pump pressure until coverage is uniform and even (see sprayer instruction manual for additional information).

Aligning Spray

1. **Relieve Pressure.** Engage trigger lock.
2. Loosen guard retaining nut.
3. Align guard horizontally to spray a horizontal pattern, vertically to spray a vertical pattern.



Clearing Clogs

1. Engage trigger lock.
2. Rotate tip 180°. Disengage trigger lock. Trigger gun into pail or onto ground to remove clog.
3. Engage trigger lock. Rotate tip 180° back to spray position.

Cleanup

Flush gun after each work shift and store in a dry location. Do not leave the gun or any parts in water or cleaning solvents.

Parts

*Kit 288817 repairs both series A and B guns.

1a replaces these three components of series A.

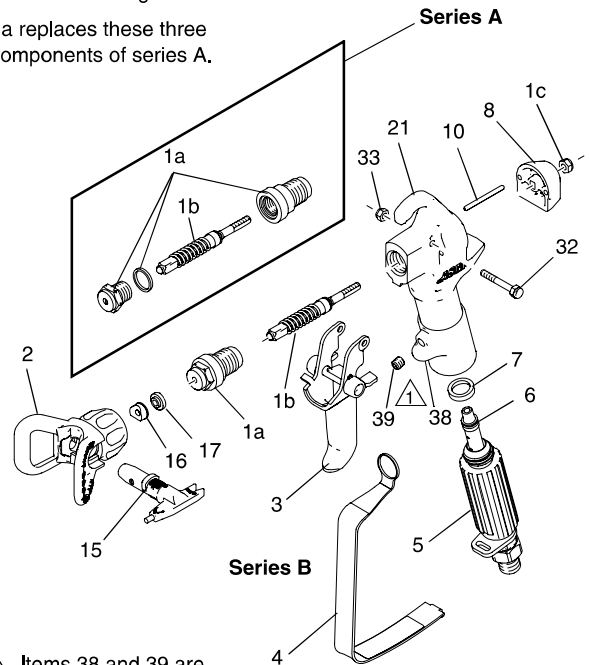

⚠ Items 38 and 39 are included with Models 289316 and 289283 only.

ti15354b

Ref	Part	Description	Qty
1	288817	DIFFUSER/SEAT KIT (includes 1a, 1b, 1c)	1
1a		SEAT, valve	1
1b		NEEDLE	1
1c		NUT, lock	1
2	248200	GUARD, tip	1
3	255126	TRIGGER, 4 finger (288681, 289284)	1
	255127	TRIGGER, 2 finger (289316, 289283)	1
4	195495	GUARD, trigger	1
5	287412	HANDLE, gun	1
6	4433-2	FILTER, mesh 50, white (standard)	1
	4434-2	FILTER, mesh 100, yellow (optional)	1
	4435-2	FILTER, mesh 200, red (optional)	1
	4436-2	FILTER, mesh 30, green (optional)	1
7	4418	SEAL, sleeve	1
8	277430	CAP, end	1
10	115484	PIN, actuator	2
15	69-517	TIP, reversible, 517	1
16	195558	SEAT, cylinder	1
17	115524	GASKET	1
21	277429	HOUSING, fluid	1
32	177538	STUD, trigger	1
33	105334	NUT, lock, hex	1
38	15K101	GUARD, 2 finger (289316, 289283 only)	1
39	100002	SCREW, set (289316, 289283 only)	1

Maintenance/Repair

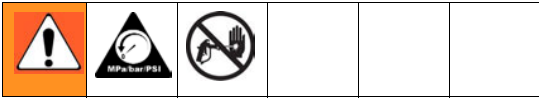

Cleaning/Replacing Filter

1. **Relieve pressure.** Engage trigger lock.
2. Disconnect hose.
3. Disconnect trigger guard (4) from guard retainer (22).
4. Unscrew handle (23) from gun.
5. Remove filter (6) through top of handle.
6. Clean filter using a soft brush.
7. Insert clean filter into handle.
8. Reattach handle to gun. Tighten securely.
9. Reconnect trigger guard to guard retainer.

Replacing Needle

1. **Relieve pressure.** Engage trigger lock.
2. Remove tip (15) and guard (2). Disconnect hose.
3. Disengage trigger lock.
4. Squeeze trigger while unscrewing diffuser/seat (1a). For Series A guns, remove needle housing and gasket.
5. Remove locknut (9) and end cap (8).
6. Tap out needle (1b) using a plastic hammer.
7. Use a soft brush to clean internal passages of gun.
8. Grease o-rings of new needle using a non-silicon grease.
9. Guide new needle into front of gun.
10. Install end cap and locknut, loosely.
11. For needle housing (1a), apply medium strength (blue) thread sealant to threads.
12. Squeeze trigger while installing needle housing. Torque to 26-32 ft-lb (35-43 N•m).

Adjusting Needle

1. **Relieve pressure.** Engage trigger lock.
2. Remove tip (15) and guard (2). Disconnect hose.
3. Disengage trigger lock.

4. Hold gun with nozzle pointing up. Turn locknut (9) clockwise (CW) until you see and feel trigger (3) raise slightly.
5. Turn locknut 3/4 turn counterclockwise (CCW). When properly adjusted, trigger will move freely.

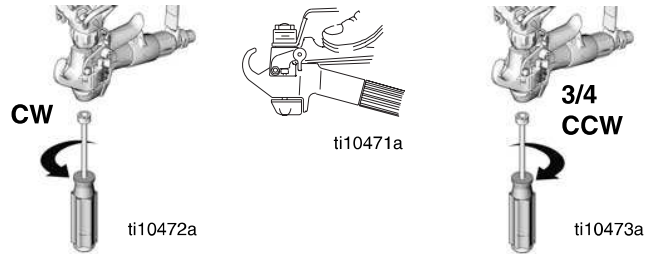

6. Connect hose. Install tip and guard. Prime sprayer.
7. Trigger gun into pail until fluid flows from gun.
8. Release trigger. Fluid flow should stop immediately.
9. Engage trigger lock. Try to trigger gun. No fluid should flow.
10. If the gun fails either test, repeat steps 1-9.

Technical Data

Maximum working pressure	3600 psi (248 bar, 25 MPa)
Fluid orifice size	0.125 in. (3.18 mm)
Weight (with tip and guard)	22 oz (630 g)
Inlet	1/4 npsm swivel
Maximum material temperature	120°F (49°C)
Wetted parts	Stainless steel, polyurethane, nylon, aluminum, tungsten carbide, solvent resistant elastomer, brass
Noise level*	
Sound power	87 dBa
Sound pressure	78 dBa

*Measured at 3.1 ft (1 m) while spraying water-based paint, specific gravity 1.36, through a 517 tip at 3000 psi (207 bar, 20.7 MPa) per ISO 3744.

All written and visual data contained in this document reflects the latest product information available at the time of publication. ASM reserves the right to make changes at any time without notice.

Original Instructions. This manual contains English. MM 312363

ASM Company, 3500 N. 1st Avenue, Sioux Falls, SD 57104

Copyright 2007

www.asmcompany.com

Revised 10/2010