

ATOMEX™

GM-70G
Airless Sprayer



INSTRUCTION MANUAL

Table of Contents

Gun Information	4
Gun Maintenance	6
Airless Paint Hose	7
Airless Gun Tips	8
Operation Procedure	10
Clean Up & Maintenance	11
Troubleshooting	12
Warranty	14
Gun Manual	19
Motor Manual	42

Description

Airless paint sprayers are capable of spraying a wide variety of latex, oil based, and water based paints, as well as stains, preservatives and other non-abrasive finishes.

These sprayers are powerful and versatile enough to be used with a variety of accessories to make them more efficient.

NOTE: Guns pictured in illustrations may be different to the one included with your unit.

Safety Guidelines

This manual contains information that is very important to know and understand. This information is provided for your SAFETY and to PREVENT EQUIPMENT PROBLEMS. To help recognize this information, observe the following symbols.

! DANGER

Danger indicates an imminently hazardous situation which, if not avoided, will result in death or serious injury.

! WARNING

Warning indicates a potentially hazardous situation which, if not avoided, could result in death or serious injury.

! CAUTION

Caution indicates a potentially hazardous situation which, if not avoided, may result in minor or moderate injury.

Unpacking

After unpacking the unit, inspect carefully for any damage that may have occurred during transit. Make sure to tighten fittings, bolts, etc. before using the unit.

! WARNING

Do not operate a damaged unit, as it may result in a malfunction which can cause injury and/or property damage.

General Safety

Read all manuals included with this product carefully. Be thoroughly familiar with the controls and the proper use of the equipment.

Always wear a mask or respirator and eye protection when painting.

Keep visitors away and NEVER allow children or pets in the work area.

Application Chart

Coating	Can Use	Do Not Use	Tip Size	Spray Pressure
Oil Base Stain	x		.011-.013"	1500+ Psi
Wood Sealer	x		.011-.013"	1500+ Psi
Concrete Sealer	x		.011-.013"	1500+ Psi
Enamel	x		.011-.013"	2000+ Psi
Varnish	x		.011-.013"	2000+ Psi
Non-Metal-Flake-Aluminum Paint	x		.011-.017"	2000+ Psi
Vinyl Latex Paint	x		.013-.017"	2000+ Psi
Vinyl/Acrylic Latex Paint	x		.013-.017"	2000+ Psi
Acrylic Latex Paint	x		.013-.017"	2000+ Psi
Oil Base Paint	x		.013-.017"	2000+ Psi
Oil and WaterBased Primer	x		.013-.017"	2000+ Psi
V.V/A&ALatex Stain	x		.013"	2000+ Psi
Textured Coatings		x	N/A	
Elastomers		x	N/A	
Asphalt Coating		x	N/A	
Wood Restorer		x	N/A	
lock Filler		x	N/A	



AIRLESS PAINT SPRAYING WHAT IS IT?

What is Airless Paint Spraying?

As the names suggests, airless paint spraying allows paint and other related material to be sprayed without the use of compressed air. The spray action is caused by pumping the material at extremely high pressures through a small opening at the tip of an airless spray gun. The high velocity with which material passes through the nozzle causes it to atomize into fine spray while maintaining sufficient momentum to carry the particles to the surface. This process is known as atomisation.

An example of what is actually occurring can be ascertained when one watches water from the garden hose pass through a nozzle. Because the nozzle opening is much smaller than the fluid passage in the hose, there is a build-up of pressure which causes the water to separate into a fine spray when it is released. Due to the low viscosity of water, this is accomplished at very low pressure (40 PSI). Paint and other coating materials, however, have much higher viscosities, requiring higher pressures (1,000 - 3,000 PSI) to separate the particles and allow atomisation. Therefore, the key elements in an airless system are pressure, and a small opening to increase the velocity of the material which thereby creates atomisation.

Why Airless Paint Spraying?

The combination of high pressure and the precise opening in the nozzle (which defines the spray pattern) allows the operator to apply coatings at maximum efficiency with very little over-spray. A second coat is quite often not required due to the uniform coverage achieved by airless spraying.

EFFICIENCY

IMPROVED PRODUCTION CAPABILITIES

INCREASED PROFITS

ATOMEX X-360 FEATURES AND BENEFITS

Professional Airless Gun

Versatility, Durability and Comfort for the Painting profession.

The ATOMEX X-360 professional airless spray gun has been designed to meet the heavy, daily requirements of professional painting contractors. Lightweight and comfortable, the ATOMEX X-360 provides effortless control and minimises the hand fatigue that often results from working house after hour.

- Metal construction to withstand daily use
- In-handle filter reduces clogging and increase tip life
- Self-cleaning, reversible tip eliminated tip clogs
- A tungsten carbide ball valve and seat
- A tungsten carbide ball bearing swivel
- Light four-finger pull for comfort and trigger guard and safety lock for added protection
- Lightweight - just 20 ozs. Accepts any tip, pole extension, power roller or a universal swivel without an adaptor.



Technical Information

- Pressure rated @ 3600 PSI, 252 BAR
- Weight: 20 oz.
- 3/16 inlet
- Tungsten carbide ball value and swivel
- Comes equipped with a X-75HD Tip
- Comes equipped with a 60 mesh filter
- Product No. AX/02-360-000

ATOMEX X-360 COMMON QUESTIONS

Can I use the ATOMEX X-360 with another manufacturer's airless spray painting unit?

Yes. The ATOMEX X-360 can be used with any airless spray painting unit. However, be certain not to exceed recommended pressure ratings of 3600 PSI.

Can the on-off valve in the ATOMEX X-360 be replaced?

Yes. The procedure is quite simple and is outlined under Installation and Service in this section. It also is included on each instruction sheet.

Can other types of airless tips be used?

Yes. They accept any tip, extension or pressure roller.

MAINTENANCE AND CLEANING

1. Cleanliness is important to assure trouble free operation. Flush unit after each use.

! WARNING

Important: When flushing, always remove tip, adjust pressure to lowest possible setting, and hold gun firmly against metal container to prevent static sparking. Use only metal containers.

2. Trigger can be placed in a lock-on position by pulling trigger and rotating safety lock towards back of gun. Important: This lock-on feature should never be used while spraying. Use for flushing only, when tip is removed and pressure is adjusted to lowest possible setting.

! CAUTION

3. Store clean unit in a dry place. Do not leave in water or solvents.

AIRLESS PAINT HOSE

Construction

- Flexible polyurethane cover and textile braid reinforcing allows for expansion and contraction
- Nylon inner core to resist solvents and absorption
- Continuous conductive core provides grounding
- Permanent end couplings
- 3300 p.s.i. working pressure
- 13,200 p.s.i. burst pressure (safety factor of 4)
- Do not use hose other than proper airless paint spraying hose which **MUST** be continually conductive.



Hose Length

- Paint hose available in 15m lengths with optional lengths on request
- A minimum of 15m paint hose must be used on Atomex sprayers (serves as buffer or pressure accumulator - use of shorted paint hose results in pulsations).



UNDERSTANDING AIRLESS TIPS

Airless tips are a key component to the successful operation of an airless system. They define the spray pattern, control the flow and ultimately tell each pump how hard it must work. Airless tips are available in many different styles, each offering an assortment of fan widths and orifice sizes (actual opening measured in thousandths of an inch). The orifice size determines the amount of fluid to be sprayed while the shape of the orifice determines the fan width. The orifice is always elliptical in shape and therefore creates a similarly shaped spray pattern. The more elongate the orifice, the wider the spray pattern.

Airless Tip Care

Due to the small opening (orifice) in an airless tip (approximately half the diameter of a pin), tip plugs can present a problem. Therefore, it is essential to always clean the equipment properly, strain the paint and always use pumps and guns which incorporate filters. Additionally, a self cleaning tip is always recommended.

The high pressure generated by airless requires that the tip be constructed of tungsten carbide. Although extremely hard, tungsten carbide is brittle. Therefore, a sharp object such as a nail should never be used to probe an airless tip while cleaning or to remove a clog. Always clean an airless tip in solvents with a soft bristle or compressed air. And store in a dry area.

Tip Selection

Proper tip selection is critical to the success or failure of the airless system. It is therefore essential to understand the method of referencing the orifice and fan width. Although there are several different numbering systems utilised by different manufacturers, remember that each in its own way will identify the orifice and fan width. The most common method of identification works as follows.

517

The first digit (5) indicates 1/2 of the minimum fan width. Add 2" for maximum fan width. (5 = a 10" to 12" pattern while spraying 12" from surface)

The last two digits (17) indicates the equivalent orifice size: (17 = 0.017) Measured in thousandths of an inch.

EXAMPLES

The larger the orifice with the same fan width, the greater the volume of paint applied to the same area.

Fan Width:	10"	10"	10"
Orifice Size:	0.017	0.021	0.026
Tip No.	517	521	526
	Least volume	More volume	Most volume

Conversely, the larger the fan width with the same orifice means the same amount of material is being applied of a greater area. The result is less volume per square inch.

Fan Width:	8"	12"	16"
Orifice Size:	0.017	0.017	0.017
Tip No.	417	617	817

As the fan width becomes more elongated, the fan width increases and tip plugs become more commonplace.

Fan width:	10"	16"	more
Tip No.	517	817	susceptible to clogging

Light bodied materials such as lacquer and stains will most commonly be used with smaller orifice tips. Heaver bodied materials will require large orifice openings.

The following chart indicates the most common sizes and the appropriate materials to be sprayed.

- 0.011 - 0.013 Lacquers and Stains
- 0.015 - 0.019 Oil and Latex
- 0.021 - 0.026 Heavy Bodied Latex and Block fillers

Fans widths measuring 8" to 12" are most preferred because they offer more control while spraying and are less likely to plug.

ATOMEX GM SERIES OPERATION PROCEDURE

PREPARATION

1. Connect paint hose, suction hose, return hose and airless gun properly
2. Check the oil levels
3. Check that unit is switched “off” connect to 240V power. Do not exceed 15 metres if using extension cord.

! WARNING

All power supplies and cords must be earthed.

START

1. Turn relief valve anti-clockwise to its limit
2. Turn pressure regulating valve clockwise to its limits.
3. Insert suction and return hoses into material to be sprayed.
4. Switch on motor and turn pressure regulating knob slowly clockwise.
5. When material is being returned to the can via the return hose (when bubbles stop appearing in the can) the pump is primed.
6. Turn the relief valve clockwise slowly to its limit. Wait for the hose to fill with material and the pressure gauge indicates approximately 3000 p.s.i. and adjusts pressure to suit material.

You are now ready to spray

SAFETY INSTRUCTIONS

! DANGER

1. Never pull the trigger of the gun toward people. Unlock the trigger **ONLY** when you spray the paint or take off the nozzle tip.
2. Never use a damaged hose. Due to the high pressure even a small flaw may cause an accident.
3. Pressure is very high and extremely dangerous. You must handle it with meticulous care.
4. Do not raise the pressure unnecessarily.
5. Connect all the attachments properly and tightly so that no paint would leak. If paint leaks while you are working, stop the pump immediately. Let the air go and lower the pressure.
6. Ensure you are using the correct hose. Refer to page 7 or contact your supplier if in doubt.

CLEAN UP

1. Cleanliness is extremely important.
2. Clean the sprayer at the end of each day's usage.
3. Shut off the sprayer.
4. Relieve the pressure by opening the prime valve.
5. Set trigger safety lock.
6. Remove spray tip and soak in solvent.
7. Place sump hose in a container of solvent. With water-based paints, use water. With oil paint, use solvent recommended by the paint manufacturer.
8. Place the prime hose in a second container.
9. Turn on the sprayer and increase the pressure by turning pressure control knob clockwise until solvent or water flows from the prime hose. Continue for 3-4 minutes or until the solvent water is clear. Then close the prime valve.
10. Trigger the gun into the paint can until solvent/water appears.
11. Trigger the gun into the container of solvent. Continue for 3-4 minutes or until the solvent/water is clear.

! DANGER

12. IMPORTANT - Hold the gun firmly against the metal container to prevent static spark.
13. You may speed up the cleanup process by increasing the pressure. Hold the nozzle of the gun under the water/solvent to avoid splashing.
14. Make the final flush with water and ATOMEX Pump Saver.
15. Shut off the sprayer. Trigger the gun to relieve pressure. Set the safety lock on the gun. Unplug the sprayer.
16. For change of colours, follow steps 3-13.
17. If using water-based paint, flush thoroughly with water and make final flush with ATOMEX Pump Saver.
18. If using oil base paint, flush thoroughly with appropriate solvent. Make final flush with turps - oil mix or kerosene.
19. Do not flush with turpentine only (this leaves gum deposits).

MAINTENANCE AND INSPECTION

Oil Change

First oil change to be carried out after **50 hours** of use

Every other oil change to be carried out every **200 hours** of use

Check head bolt tension every six months – Head bolt tension is 57ft/lb

To drain the oil, take off the cap and unplug the drain-plug.

Use hydraulic oil in the pump. (Max. 1 Litre.)

The amount poured will be seen at the oil gauge. If you pour too much, it will leak through the oil breather valve.



GM-70G Instruction Manual

PROBLEM	CAUSE	SOLUTION
Sprayer does not start or stops after running	<ol style="list-style-type: none"> 1) No electrical power, cord unplugged, blown fuse. 2) Thermal protector switch open 	<p>check power, cord, fuses.</p> <p>Let sprayer cool. Reset switch. Correct overload cause.</p>
Sprayer will not prime	<ol style="list-style-type: none"> 1) Prime valve closed. 2) Inlet or outlet valve sticking. 3) Inlet strainer screen dirty. 4) Pressure control knob set too low. 5) Worn inlet valve or outlet. 6) Paint too thick. 7) Clogged filter screen. 	<p>Open prime valve</p> <p>Clean inlet or outlet valve</p> <p>Clean</p> <p>Turn knob clockwise, increase pressure</p> <p>Replace</p> <p>Thin paint as needed</p> <p>Clean filter</p>
Sprayer primes, builds pressure, but pressure drops greatly when trigger is pulled	<ol style="list-style-type: none"> 1) No tip in gun. 2) Worn tip. 3) Worn outlet ball or seat. 4) Worn outlet valve. 	<p>Install tip</p> <p>Replace tip</p> <p>Replace inlet valve</p>
Poor spray pattern, tails or finger-ing of spray pattern	<ol style="list-style-type: none"> 1) Worn tip. 2) Spray tip too large. 3) Paint too thick or poor quality. 4) Pressure too low. 5) Paint hose too long. 6) Clogged inlet strainer screen. 7) Clogged filter screen. 8) Dirty or worn valves. 	<p>Replace tip</p> <p>Replace with smaller tip</p> <p>Thin paint or replace</p> <p>Increased pressure</p> <p>Use shorted paint hose</p> <p>Clean</p> <p>Clean</p> <p>Clean or replace inlet and/or out-let valve</p>
Coarse spray pattern	Low pressure.	Increase pressure
Thin centre	<ol style="list-style-type: none"> 1) Wrong tip. 2) Material too thick. 	<p>Use larger tip and/or narrower</p> <p>Thin cautiously</p>
Excessive fogging	<ol style="list-style-type: none"> 1) High pressure. 2) Wrong tip or worn tip. 3) Material too thin. 	<p>Reduce pressure but maintain pattern</p> <p>Use smaller tip but only if less flow is desired or replace</p> <p>Use less thinner</p>
Pattern too wide	Fan angle too large.	Use narrower fan angle
Pattern too narrow	Fan angle too narrow.	Use wider fan angle
Too much material	Tip too large.	Use smaller tip size
Too little material	Tip too small	Use larger tip size
Clogged tip	Tip clogged. Screens not proper size for tip. Paint too coarse.	Clean carefully. Use smaller mesh screen. Use larger tip.



PROBLEM	CAUSE	SOLUTION
Spray pattern irregular, deflected	1) Tip partially clogged. 2) Tip damaged.	Clean carefully Replace with new tip
Clogged screens	Extraneous material in paint	Clean screen

**For technical assistance
Please contact:**



29 Carlingford Rd, Regents Park NSW 2143
Phone (02) 9644 1040 FAX (02) 9644 3147
Email: info@atomex.com.au

www.atomex.com.au

Notes



WARRANTY

ATOMEX Airless sprayers are guaranteed to be free from faults in workmanship or materials for a period of 25 months after the original purchase date.

Check the unit immediately on receipt. Any discrepancy or defect shall not be recognised unless ATOMEX are notified of such within (7) seven days. (This also applies to any servicing or repairs carried out by ATOMEX).

To claim service under warranty, the complete unit must be returned by prepaid freight to the ATOMEX service centre/office in your state. At ATOMEX' discretion, the damage, fault or wear, is not covered by the warranty terms all repairs and parts cost shall be borne by the owner.

Items not covered by the warranty include:

1. Corrosion to any part or accessory of the unit due to incorrect or unsatisfactory maintenance.
2. Wear caused by any abrasive media, to any valve or part there of, spray tips, spray guns filters, seals and any other part in contact with the material flow.
3. Incorrect or negligent handling, assembly, third party servicing, operation or use.
4. Normal wear and tear.
5. The use of other than genuine approved ATOMEX parts and accessories causing damage shall void the warranty.
6. High pressure hoses that have been kinked (minimum bend radius = 100mm approx.), squashed or abraded externally.
7. Liability extended only to the unit. Direct or indirect damage is not covered.

This warranty is supplemental and is in addition to those warranties implied by law.

Note: Before returning for warranty, please read the manual carefully.

GM-70G DIAPHRAGM PUMP BREAKDOWN

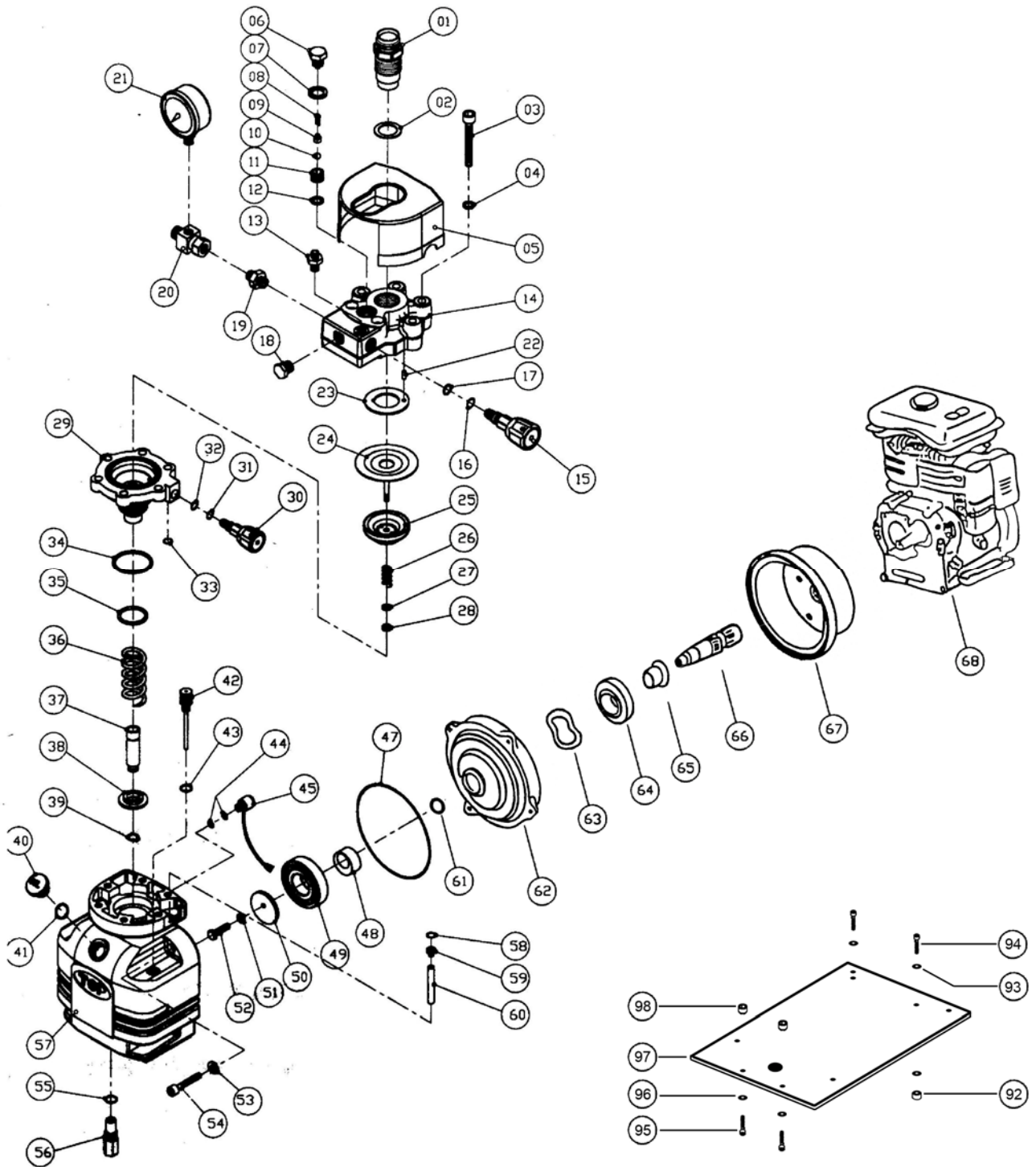



GM-70G Instruction Manual

Item No	Part Number	Description	Qty
1	AX/GM-60001	Suction Valve Complete	1
2	AX/GM-60002	Gasket	1
3	AX/GM-60003	Bolt	6
4	AX/GM-60004	Washer	6
5	AX/GM-60005	Shield	1
6	AX/GM-60006	Union End Cap	1
7	AX/GM-60007	Washer	1
8	AX/GM-60008	Spring	1
9	AX/GM-60009	Spring Support	1
10	AX/GM-60010	Ball - Carbide Steel	1
11	AX/GM-60011	Outlet Valve Seat	1
12	AX/GM-60012	Sealing Washer	1
13	AX/GM-60013	Nipple	1
14	AX/GM-60014	Head Manifold	1
15	AX/GM-60015	Relief Valve	1
16	AX/GM-60016	O - Ring	1
17	AX/GM-60017	Gasket	1
18	AX/GM-60018	Plug	1
19	AX/GM-60019	Nipple	1
20	AX/GM-60020	Swivel Nipple	1
21	AX/GM-60021	Pressure Gauge	1
22	AX/GM-60022	Pin	1
23	AX/GM-60023	Washer	1
24	AX/GM-60024	Diaphragm	1
25	AX/GM-60025	Gland	1
26	AX/GM-60026	Spring	1
27	AX/GM-60027	Washer	1
28	AX/GM-60028	Nut	1
29	AX/GM-60029	Housing	1
30	AX/GM-60030	Pressure Valve (Red)	1
31	AX/GM-60031	O - Ring	1
32	AX/GM-60032	Gasket	1
33	AX/GM-60033	O - Ring	1
34	AX/GM-60034	O - Ring	1
35	AX/GM-60035	O - Ring	1
36	AX/GM-60036	Spring	1
37	AX/GM-60037	Plunger	1
38	AX/GM-60038	Gland	1
39	AX/GM-60039	Snap Ring	1
40	AX/GM-60040	Oil Cap	1
41	AX/GM-60041	O - Ring	1
42	AX/GM-60042	Flow Meter	1
43	AX/GM-60043	O - Ring	1
44	AX/GM-60044	O - Ring	2
45	AX/GM-60045	Oil Filter	1
46	AX/GM-60046	Motor	1
47	AX/GM-60047	O - Ring	1
48	AX/GM-60048	Crank Washer	1
49	AX/GM-60049	Bearing	1
50	AX/GM-60050	Washer	1
51	AX/GM-60051	Washer	1
52	AX/GM-60052	Bolt	1
53	AX/GM-60053	Washer	1
54	AX/GM-60054	Bolt	1
55	AX/GM-60055	O - Ring	1
56	AX/GM-60056	Plug	1
57	AX/GM-60057	Oil Case	1
58	AX/GM-60058	O - Ring	1
59	AX/GM-60059	Bushing	1
60	AX/GM-60060	Tube	1
61	AX/GM-60061	Coupling Housing - Front Seal	1
61	AX/GM-60061	Coupling Housing - Front Seal	1
62	AX/GM-60062	Coupling Housing - Front Hosuing	1
63	AX/GM-60063	Coupling Housing - Thrust Washer	1
64	AX/GM-60064	Coupling Housing - Centre Bearing	1
65	AX/GM-60065	Coupling Housing - Centre Bearing Sleeve	1
66	AX/GM-60066	Coupling Housing - Shaft Assembly	1
67	AX/GM-60067	Coupling Housing - Rear Housing	1
68	AX/GM-60068	Honda GX-200 Motor	1
92	AX/LM-70092	LM Plate - Nut	2
93	AX/LM-70093	LM Plate - Washer	4
94	AX/LM-70094	LM Plate - Bolt	2
95	AX/LM-70095	LM Plate - Bolt	2
96	AX/LM-70096	LM Plate - Washer	2
97	AX/LM-70097	LM Plate - Plate	1
98	AX/LM-70098	LM Plate - Spacer	2

SUCTION SET BREAKDOWN

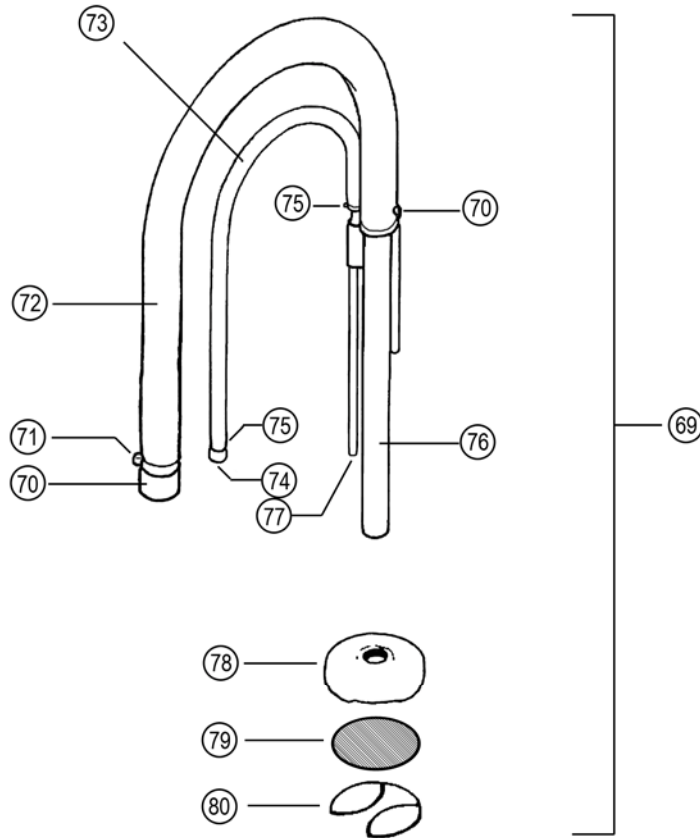

Item No	Part Number	Description	Qty
69	AX/GM-60069	Suction Set - Complete	1
70	AX/GM-60070	Suction Set - 1" Nut & Tail	1
71	AX/GM-60071	Suction Set - Clamp	2
72	AX/GM-60072	Suction Set - Suction Hose Only	1
73	AX/GM-60073	Suction Set - Return Hose Only	1
74	AX/GM-60074	Suction Set - 3/8" Nut & Tail	1
75	AX/GM-60075	Suction Set - Return Tube Clamp	2
76	AX/GM-60076	Suction Set - Suction Pipe	1
77	AX/GM-60077	Suction Set - Return Tube	1
78	AX/GM-60078	Suction Set - Filter Bell	1
79	AX/GM-60079	Suction Set - Filter Mesh	1
80	AX/GM-60080	Suction Set - Filter Clip	1

GM-70G FRAME BREAKDOWN

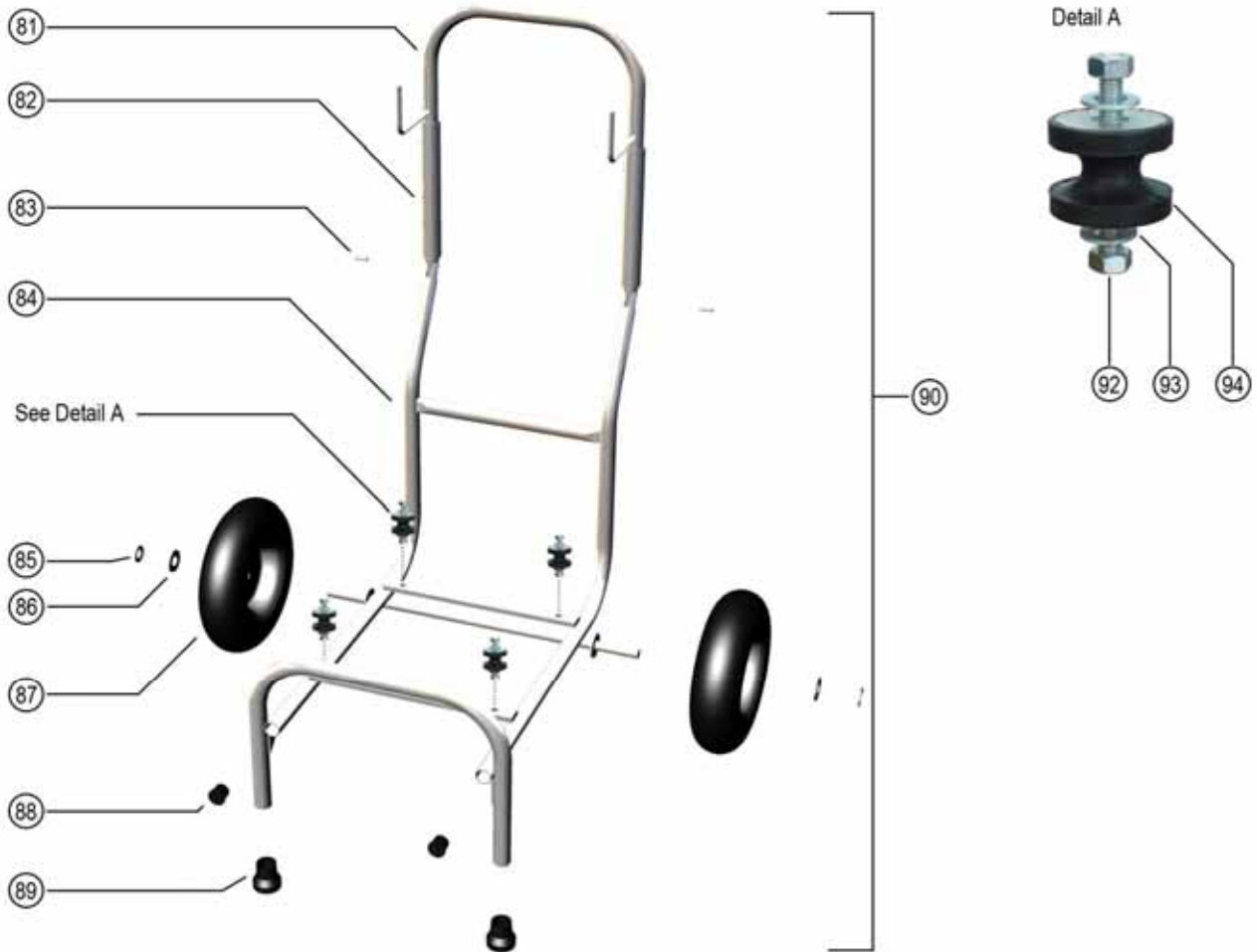

Item No	Part Number	Description	Qty
81	AX/GM-60081	Handle	1
82	AX/GM-60082	Handle Sleeve	2
83	AX/GM-60083	Pin	2
84	AX/GM-60084A	GM-70G Main Section	1
85	AX/GM-60085	Retaining Clip	2
86	AX/GM-60086	Washer	2
87	AX/GM-60087	Pneumatic Tyre	2
88	AX/GM-60088	Tube Plug	2
89	AX/GM-60089	Tube Stop	2
90	AX/GM-60091	Frame - Complete	1
92	AX/GM-60092	Anti Vibration Mount Nut	8
93	AX/GM-60093	Anti Vibration Mount Washer	8
94	AX/GM-60094	Anti Vibration Mount	4



OWNER'S MANUAL

X-360 Professional Airless Spray Gun
For TRAINED, PROFESSIONAL USE ONLY!

Maximum Working Pressure:
3600 PSI - 250 BAR - 24.5 Mpa

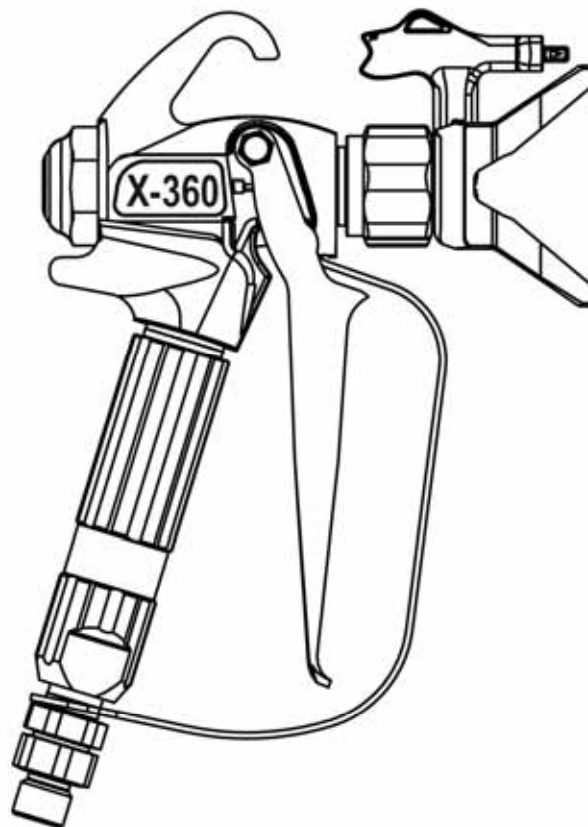

Part No. AX/02-360-000 7/8" Thread
AX/02-360-001 11/16" Thread

!! SAFETY and OPERATING INSTRUCTIONS INSIDE !!
Read all warnings and safe operating information inside
SAVE THIS MANUAL FOR FUTURE REFERENCE



⚠ WARNING
Keep clear of nozzle

"Do not exceed maximum working pressure."

Safety Precautions

WARNING

- HAZARD:** Injection injury - A high pressure stream produced by this equipment can pierce the skin and underlying tissues, leading to a serious injury and possible amputation.
- See a physician immediately.

DO NOT TREAT AN INJECTION INJURY AS A SIMPLE CUT!
Injection can lead to amputation. See a physician immediately.

The maximum operating range of the gun is 3600 PSI / 250 bar fluid pressure.

PREVENTION:

- **NEVER** aim the gun at any part of the body.
- **NEVER** allow any part of the body to touch the fluid stream. **DO NOT** allow body to touch a leak in the fluid hose.
- **NEVER** put hand in front of the gun. Gloves will not provide protection against an injection injury.
- **ALWAYS** lock the gun trigger, shut the pump off, and release all pressure before servicing, cleaning the tip or guard, changing tip, or leaving unattended. Pressure will not be released by turning off the motor. The PRIME/SPRAY valve must be turned to PRIME to relieve the pressure. Refer to the **PRESSURE RELIEF PROCEDURE** described in the pump manual.
- **ALWAYS** keep the tip guard in place while spraying. The tip guard provides some protection but is mainly a warning device.
- **ALWAYS** remove the spray tip before flushing or cleaning the system.
- The paint hose can develop leaks from wear, kinking and abuse. A leak can inject material into the skin. Inspect the hose before each use.
- **NEVER** use a spray gun without a trigger lock and trigger guard in place and in good working order.
- All accessories must be rated at or above the maximum operating pressure range of the airless sprayer. This includes spray tips, guns, extensions, and hose.

NOTE TO PHYSICIAN:

Injection into the skin is a traumatic injury. It is important to treat the injury as soon as possible. **DO NOT DELAY** treatment to research toxicity. Toxicity is a concern with some coatings injected directly into the blood stream. Consultation with a plastic surgeon or reconstructive hand surgeon may be advisable.

- HAZARD:** EXPLOSION OR FIRE - Solvent and paint fumes can explode or ignite. Severe injury and/or property damage can occur.
-

PREVENTION:

- Provide extensive exhaust and fresh air introduction to keep the air within the spray area free from accumulation of flammable vapors.
- Avoid all ignition sources such as static electricity sparks, electrical appliances, flames, pilot lights, hot objects, and sparks from connecting and disconnection power cords or working light switches.
- Do not smoke in spray area.
- Fire extinguisher must be present and in good working order.
- Place pump at least 25 feet (7.6m) away from the spray object in a well ventilated area (add more hose if necessary). Flammable vapors are often heavier than air. Floor area must be extremely well ventilated. The pump may contain arcing parts that emit sparks and can ignite vapors.
- The equipment and objects in and around the spray area must be properly grounded to prevent static sparks.
- Use only conductive or grounded high pressure fluid hose. Gun must be grounded through hose connections.
- Power cords must be connected to a grounded circuit.



- Always flush unit into a separate metal container, at low pump pressure, with spray tip removed. Hold gun firmly against side of container to ground container and prevent static sparks.
- Follow the material and solvent manufacturer's warnings and instructions.
- Use extreme caution when using materials with a flashpoint below 70° F (21° C). Flashpoint is the temperature that a fluid can produce enough vapors to ignite.
- Plastic can cause static sparks. Never hang plastic to enclose a spray area. Do not use plastic drop cloths when spraying flammable materials.
- Use lowest possible pressure to flush equipment.

HAZARD: EXPLOSION HAZARD DUE TO INCOMPATIBLE MATERIALS - will cause severe injury or property damage.

PREVENTION:

- Do not use materials containing bleach or chlorine.
- Do not use halogenated hydrocarbon solvents such as bleach, mildewcide, methylene chloride and 1,1,1 - trichloroethane. They are not compatible with aluminum.
- Contact your coating supplier about the compatibility of material with aluminum.

HAZARD: HAZARDOUS VAPORS - Paints, solvents, insecticides, and other materials can be harmful if inhaled or come in contact with the body. Vapors can cause severe nausea, fainting, or poisoning.

PREVENTION:

- Use a respirator or mask if vapors can be inhaled. Read all instructions supplied with the mask to be sure it will provide the necessary protection.
- Wear protective eyewear.
- Wear protective clothing as required by coating manufacturer.

HAZARD: GENERAL - Can cause severe injury or property damage.

PREVENTION:

- Read all instructions and safety precautions before operating equipment.
- Always disconnect the motor from the power supply before working on the equipment.
- Follow all appropriate local, state, and national codes governing ventilation, fire prevention, and operation.
- The United States Government Safety Standards have been adopted under the Occupational Safety and Health Act (OSHA). These standards, particularly part 1926 of the Construction Standards should be consulted.
- Use only manufacturer authorized parts. User assumes all risks and liabilities when using parts that do not meet the minimum specifications and safety devices of the pump manufacturer.
- Before each use, check all hoses for cuts, leaks, abrasion or bulging of cover. Check for damage or movement of couplings. Immediately replace the hose if any of these conditions exist. Never repair a paint hose. Replace it with another grounded high-pressure hose.
- All hoses, swivels, guns, and accessories must be pressure rated at or above the maximum operating pressure range of the airless sprayer.
- Do not spray outdoors on windy days.
- Wear clothing to keep paint off skin and hair.

The following are general WARNINGS related to the setup, use, grounding, maintenance and repair of this equipment.

⚠ WARNING

FIRE AND EXPLOSION HAZARD

Flammable fumes, such as solvents and paint fumes, in work area can ignite or explode. To help prevent fire and explosion:

- Use equipment only in well ventilated area.
- Eliminate all ignition sources; such as pilot lights, cigarettes, portable electric lamps, and plastic drop clothes (potential static arc.)
- Keep work area free of debris, including solvent, rags and gasoline.
- Sprayers generate sparks. When flammable liquid is used in or near sprayer or for flushing or cleaning, keep sprayer at least 20 feet (6m) away from explosive vapors.
- Do not plug or unplug power cords or turn lights on or off when flammable fumes are present.
- Ground equipment and conductive objects in work area.
- If there is static sparking or you feel a shock, **stop operating immediately**. Do not use equipment until you identify and correct the problem.
- Keep a fire extinguisher in the work area.

SKIN INJECTION HAZARD

High pressure fluid from spray gun, hose leaks or ruptured components will pierce skin. This may look like just a cut, but it is a serious injury that can cause amputation.

Seek immediate surgical treatment.

- Do not point gun at anyone or any part of the body.
- Do not put your hand over the spray tip.
- Do not stop or deflect leaks with your hand, body, glove or rag.
- Do not spray without tip guard and trigger guard installed.
- Engage trigger lock when not spraying.
- Follow pressure relief procedure for your sprayer when you stop spraying and before cleaning, checking or servicing your equipment.

EQUIPMENT MISUSE HAZARD

Misuse can cause death or serious injury.

- Do not exceed the maximum working pressure or temperature rating of the lowest rated system component. See the technical data in all equipment manuals.
- Use fluids and solvents that are compatible with your equipment wetted parts. See technical data in all equipment manuals. Read fluid and solvent manufacturer's warnings. For complete information about your material, request MSDS from your distributor or retailer.
- Check your equipment daily. Repair or replace worn or damaged parts immediately with genuine TriTech replacement parts only.
- Do not alter or modify equipment.
- Use equipment only for its intended purpose. Call TriTech for more information.
- Route hoses and cables away from traffic areas, sharp edges, moving parts and hot surfaces.
- Do not kink or overbend hoses or use hoses to pull equipment.
- Keep children and animals away from work area.
- Comply with all applicable safety regulations.
- Do not operate equipment when fatigued or under the influence of drugs or alcohol.

PRESSURIZED ALUMINUM PARTS HAZARD

Do not use 1,1,1-trichloroethane, methylene chloride, other halogenated hydrocarbon solvents or fluids containing such solvents in this equipment. Such use could result in a serious chemical reaction, with the possibility of explosion, which could cause death, serious injury and/or substantial property damage.

Les mises en garde suivantes sont des MISES EN GARDE de sécurité relatives à la configuration, l'utilisation, la mise à la terre, la maintenance et la réparation de ce matériel.

▲ MISE EN GARDE

DANGER D'INCENDIE ET D'EXPLOSION

Les vapeurs inflammables, vapeurs de solvants et de peinture par exemple, sur le lieu de travail peuvent s'enflammer ou exploser. Pour prévenir un incendie ou une explosion:

- N'utiliser l'équipement que dans des locaux bien ventilés.
- Supprimer toutes les sources de feu, telles que les veilleuses, cigarettes, lampes électriques portatives et bâches plastiques (risque de décharge d'électricité statique).
- Veiller à débarrasser la zone de travail de tout résidu, comme les solvants, les chiffons et l'essence.
- Les pulvérisateurs produisent des étincelles. En cas d'utilisation de liquide inflammable dans ou près du pulvérisateur ou encore pour rincer ou nettoyer, tenir le pulvérisateur à un minimum de 20 ft (6 m) des vapeurs explosives.
- Ne pas brancher ni débrancher de cordons d'alimentation électrique ni allumer ou éteindre la lumière en présence de vapeurs inflammables.
- Raccorder le matériel et les objets conducteurs se trouvant dans la zone de travail à la terre.
- Si l'on remarque la moindre étincelle d'électricité statique ou si l'on ressent une décharge électrique, arrêter le travail immédiatement. Ne pas utiliser le matériel tant que le problème n'a pas été identifié et résolu.
- La présence d'un extincteur est obligatoire dans la zone de travail.

DANGERS D'INJECTIONS

Le produit s'échappant à haute pression du pistolet, d'une fuite sur le flexible ou d'un composant défectueux risque de transpercer la peau. La blessure peut avoir l'aspect d'une simple coupure, mais il s'agit en fait d'une blessure sérieuse pouvant entraîner une amputation.

Consulter immédiatement un médecin en vue d'une intervention chirurgicale.

- Ne pas pointer le pistolet vers une personne ou une partie quelconque du corps.
- Ne pas mettre la main devant la buse de projection.
- Ne jamais colmater ou dévier les fuites avec la main, le corps, un gant ou un chiffon.
- Ne pas pulvériser sans garde-buse ni sous-garde.
- Verrouiller la gâchette à chaque arrêt de la pulvérisation.
- Suivre la procédure de décompression de ce manuel à chaque interruption de pulvérisation et avant le nettoyage, la vérification ou l'entretien du matériel.

DANGER EN CAS DE MAUVAISE UTILISATION DE L'EQUIPEMENT

Toute mauvaise utilisation du matériel peut provoquer des blessures graves, voire mortelles.

- Ne pas dépasser la pression ou température de service maximum spécifiée de l'élément le plus faible du système. Voir les Caractéristiques techniques de tous les manuels de l'appareil.
- Utiliser des produits et solvants compatibles avec les pièces en contact avec le produit. Voir les Caractéristiques techniques de tous les manuels de l'appareil. Lire les mises en garde du fabricant de produit et de solvant. Pour plus d'informations sur votre produit, demandez la fiche de sécurité produit à votre distributeur ou revendeur de produit.
- Vérifier le matériel quotidiennement. Réparer ou remplacer immédiatement toutes les pièces usées ou endommagées uniquement par des pièces d'origine ATOMEX.
- Ne pas modifier cet équipement.
- N'utiliser ce matériel que pour l'usage auquel il est destiné. Pour plus de renseignements, appelez votre distributeur ATOMEX.
- Ecarter les flexibles et câbles électriques des zones de circulation, des bords coupants, des pièces en mouvement et des surfaces chaudes.
- Ne pas plier ni trop cintrer les flexibles ni les utiliser pour tirer l'équipement.
- Tenir les enfants et les animaux à l'écart de la zone de travail.
- Se conformer à toutes les règles de sécurité applicables.
- Ne pas utiliser l'appareil si l'on est fatigué ou sous l'influence de drogue ou d'alcool.

RISQUES DUS AUX PIÈCES EN ALUMINIUM SOUS PRESSION

N'utiliser ni 1,1,1-trichloréthane, ni chlorure de méthylène, ni solvants à base d'hydrocarbures halogénés, ni produits contenant de tels solvants dans un appareil sous pression en aluminium. L'utilisation de ces produits risque de déclencher une violente réaction chimique avec risque d'explosion pouvant provoquer de graves dommages matériels et corporels pouvant entraîner la mort.

El siguiente texto contiene ADVERTENCIAS generales acerca de la instalación, uso, conexión a tierra, mantenimiento y reparación de este equipo.

⚠ ADVERTENCIA

PELIGRO DE INCENDIO Y EXPLOSIÓN

Vapores inflamables, como por ejemplo, vapores de solventes y pintura en el área de trabajo pueden inflamarse o explotar. Para evitar incendios y explosiones:

- Utilice el equipo únicamente en un área bien ventilada.
- Elimine todas las fuentes de combustión, como por ejemplo, luces piloto, cigarrillos, lámparas eléctricas portátiles y cubiertas de plástico (arcos estáticos potenciales).
- Mantenga limpia el área de trabajo, sin solventes, trapos ni gasolina.
- La pistola genera chispas. Al utilizarse un líquido inflamable en la pistola o cerca de ella o para lavarla o limpiarla, manténgala a una distancia mínima de 6 metros de vapores explosivos.
- No enchufe ni desenchufe cables de alimentación ni encienda o apague las luces al trabajar con vapores inflamables.
- Conecte a tierra el equipo y objetos conductores en el área de trabajo.
- Si hay indicios de formación de electricidad estática o si siente una descarga, deje de trabajar inmediatamente y no utilice el equipo hasta haber identificado y corregido el problema.
- Tenga a mano un extintor de incendios en el área de trabajo.

PELIGRO DE INYECCIÓN

El líquido a alta presión procedente de la pistola, de fugas de la manguera o de componentes rotos puede penetrar la piel. Quizá parezca sólo un corte, pero se trata de una lesión grave, que puede llevar a la amputación de un miembro.

Procure atención médica inmediata.

- No apunte nunca la pistola hacia alguien o alguna parte del cuerpo.
- No coloque la mano sobre la boquilla de la pistola.
- No intente bloquear ni desviar fugas con la mano, el cuerpo, los guantes o con un trapo.
- No pulverice sin tener instalado el portaboquillas y el protector del gatillo.
- Trabe el seguro del gatillo cuando no pulveriza.
- Siga las instrucciones de descompresión al dejar de pulverizar y antes de limpiar, revisar o reparar el equipo.

PELIGRO POR UTILIZACIÓN INCORRECTA DEL EQUIPO

La utilización incorrecta puede provocar lesiones graves o mortales.

- No exceda la presión máxima de trabajo o el régimen de temperatura del componente de menor capacidad del sistema. Consulte la información técnica en todos los manuales del equipo.
- Utilice líquidos y solventes compatibles con las piezas húmedas del equipo. Consulte la información técnica en todos los manuales del equipo y lea las advertencias del fabricante acerca de líquidos y solventes. Para obtener información completa acerca del material en cuestión, solicite del distribuidor o revendedor una Ficha de datos de seguridad.
- Revise el equipo a diario. Repare o cambie de inmediato las piezas gastadas o dañadas, únicamente por piezas de repuesto originales de ATOMEX.
- No altere ni modifique el equipo.
- Utilice el equipo únicamente para los fines a los que está destinado. Para más información, póngase en contacto con ATOMEX.
- Aleje mangueras y cables de áreas de tráfico, bordes filosos, piezas en movimiento y superficies calientes.
- No retuerza ni doble las mangueras, ni las utilice para arrastrar el equipo.
- Mantenga niños y animales alejados del área de trabajo.
- Respete las normas de seguridad vigentes.
- No utilice el equipo si está fatigado o bajo la influencia de drogas o alcohol.

PELIGRO DE PIEZAS DE ALUMINIO A PRESIÓN

No utilice en el equipo 1,1,1-tricloroetano, cloruro de metileno y otros solventes o líquidos de hidrocarburos halogenados que contengan dichos solventes. Se trata de sustancias que pueden provocar una reacción química peligrosa con posibilidad de explosión, que podría causar la muerte, lesiones graves o ingentes daños materiales.

Im Folgenden finden Sie allgemeine WARNUNGEN bezüglich der Einrichtung, Verwendung, Erdung, Wartung und Reparatur dieser Anlage.

⚠️ WARNUNG!

BRAND- UND EXPLOSIONSGEFAHR

Entflammare Dämpfe wie Lösungsmittel und Farbdämpfe können sich im Arbeitsbereich entzünden oder explodieren. Um Feuer und Explosionen zu vermeiden:

- Verwenden Sie die Ausrüstung nur in gut belüftetem Bereich.
- Entfernen Sie alle Zündquellen wie Anzeigelampen, Zigaretten, tragbare elektrische Lampen und Einmalbekleidung aus Plastik (möglicher statischer Bogen).
- Halten Sie den Arbeitsbereich frei von Fremdkörpern, einschließlich Lösungsmittel, Lumpen und Benzin.
- Sprühanlagen erzeugen Funken. Werden entflammare Flüssigkeiten in oder in der Nähe der Sprühanlage verwendet oder zur Spülung oder Reinigung, halten Sie die Sprühanlage wenigstens 20 Fuß (6m) entfernt von explosiven Dämpfen.
- Stecken Sie keine Stromkabel ein oder ziehen Sie diese aus der Verbindung oder schalten Sie kein Licht ein oder aus, wenn entflammare Dämpfe vorhanden sind.
- Erdungsausrüstung und leitende Objekte im Arbeitsbereich.
- Kommt es zu statischer Funkenbildung oder Sie erhalten einen elektrischen Schlag, ist der Betrieb umgehend einzustellen. Verwenden Sie die Anlage nicht, bis Sie das Problem identifiziert und behoben haben.
- Halten Sie am Arbeitsbereich einen Feuerlöscher bereit.

GEFAHR DER HAUTVERLETZUNG

Unter hohem Druck stehende Flüssigkeiten aus einer Spritzpistole, Löchern im Schlauch oder brüchigen Komponenten durchdringen die Haut. Dies kann einfach wie ein Schnitt aussehen, dabei handelt es sich jedoch um eine schwere Verletzung, die bis zur Amputation führen kann.

Nehmen Sie umgehend ärztliche Hilfe in Anspruch.

- Halten Sie die Spritzpistole nie auf eine Person oder einen Körperteil gerichtet.
- Legen Sie nicht Ihre Hand auf die Spritzdüse.
- Stoppen oder lenken Sie Lecks nicht mit Ihrer Hand, Ihrem Körper, Handschuh oder Lappen ab.
- Sprühen Sie nicht, ohne dass der Düsenschutz und der Auslöserschutz installiert sind.
- Rasten Sie die Auslösersperre ein, wenn Sie nicht sprühen.
- Befolgen Sie den Druckausgleichablauf für Ihre Sprühanlage, wenn Sie mit dem Sprühen aufhören und bevor Sie mit der Reinigung, Überprüfung oder Wartung ihrer Anlage beginnen.

GEFAHR DURCH FALSCHEN EINSATZ DER AUSTRÜSTUNG

Falsche Verwendung kann zu Tod oder schweren Verletzungen führen.

- Überschreiten Sie nicht den maximalen Arbeitsdruck oder die maximale Temperaturauslegung der am niedrigsten ausgelegten Systemkomponente. Schlagen Sie in den technischen Daten in allen Ausrüstungshandbüchern nach.
- Verwenden Sie Flüssigkeiten und Lösungen, die mit den flüssigkeitsbenetzten Teilen der Ausrüstung kompatibel sind. Schlagen Sie in den technischen Daten in allen Ausrüstungshandbüchern nach. Lesen Sie sich die Warnungen der Hersteller von Flüssigkeiten und Lösungen durch. Für vollständige Informationen zu Ihrem Material fordern Sie die Sicherheitsdatenblätter (MSDS) Ihres Versorgers oder Lieferanten an.
- Überprüfen Sie Ihre Ausrüstung täglich. Reparieren oder ersetzen Sie abgenutzte oder beschädigte Teile umgehend nur durch Original-Ersatzteile von ATOMEX.
- Ändern oder modifizieren Sie die Anlage nicht.
- Verwenden Sie die Ausrüstung nur für den ausgelegten Zweck. Für weitere Informationen kontaktieren Sie ATOMEX.
- Verlegen Sie Schläuche und Kabel nicht im Verkehrsbereich, in der Nähe von scharfen Kanten, sich bewegenden Teilen oder heißen Oberflächen.
- Knicken oder überbiegen Sie keine Schläuche und verwenden Sie diese nicht, um an der Ausrüstung zu ziehen.
- Halten Sie Kinder und Tiere entfernt vom Arbeitsbereich.
- Stellen Sie sicher, dass Sie allen anwendbaren Sicherheitsbestimmungen entsprechen.
- Betreiben Sie die Anlage nicht, wenn Sie ermüdet sind oder unter dem Einfluss von Medikamenten, Drogen oder Alkohol stehen.

GEFAHR DURCH UNTER DRUCK STEHENDE ALUMINIUM-TEILE

Verwenden Sie in dieser Anlage nicht 1,1,1-Trichlorethan, Methylenchlorid, andere Halogenkohlenwasserstoff- Lösungen oder Flüssigkeiten, die solche Lösungsmittel enthalten. Eine solche Verwendung könnte zu einer ernsten chemischen Reaktion führen, mit der Möglichkeit einer Explosion, die wiederum zum Tod oder zu schweren Verletzungen oder Schäden an der Einrichtung führen könnte.

Grounding and Electric Requirements
Exigences électriques et de mise à la terre
Requisitos eléctricos y de conexión a tierra
Anforderungen an Erdung und Elektronik



The sprayer and gun must be grounded. Grounding reduces the risk of static and electric shock by providing an escape wire for the electrical current due to static build up or in the event of a short circuit. Follow the grounding instructions included in the equipment manual provided with your sprayer. Additional grounding instructions for this spray gun are included below.

Ce pulvérisateur et son pistolet doivent être raccordés à la terre. La mise à la terre réduit les risques d'électricité statique et de décharge électrique grâce à un fil permettant au courant de s'échapper en cas d'accumulation d'électricité statique ou de court-circuit. Suivre les instructions de mise à la terre incluses dans le manuel de l'équipement fourni avec le pulvérisateur. Des instructions supplémentaires de mise à la terre pour ce pistolet pulvérisateur sont incluses ci-dessous.

El pulverizador y la pistola deben conectarse a tierra. La puesta a tierra reduce el riesgo de choque electrostático o eléctrico, mediante un cable de descarga de la corriente eléctrica originada por la acumulación de electricidad estática o en caso de cortocircuito. Siga las instrucciones de conexión a tierra del manual del equipo que se suministra con el pulverizador. A continuación se ofrecen más instrucciones de conexión a tierra para esta pistola de pulverización.



Die Sprühanlage und die Spritzpistole müssen geerdet sein. Erdung verringert das Risiko eines statischen und elektrischen Schocks, indem dem elektrischen Strom eine Ausgleichsleitung für die statische Aufladung geboten wird oder für den Fall eines Kurzschlusses. Folgen Sie den Erdungsanweisungen, die im Handbuch zur Ausrüstung beinhaltet sind, und das Ihnen mit der Sprühanlage zur Verfügung gestellt wird. Zusätzliche Erdungsanweisungen für die Spritzpistole sind unten eingefügt.

Ground your spray gun through connection to a properly grounded fluid hose and sprayer or pump.

Raccorder le pistolet à la terre via un flexible produit et le pulvérisateur ou la pompe correctement reliés à la terre.

Ponga a tierra la pistola mediante una conexión a una manguera, pulverizador o bomba de líquidos debidamente conectados a tierra.

Erden Sie Ihre Spritzpistole durch Verbindung zu einem entsprechend geerdeten Flüssigkeitsschlauch und Sprühanlage oder Pumpe.

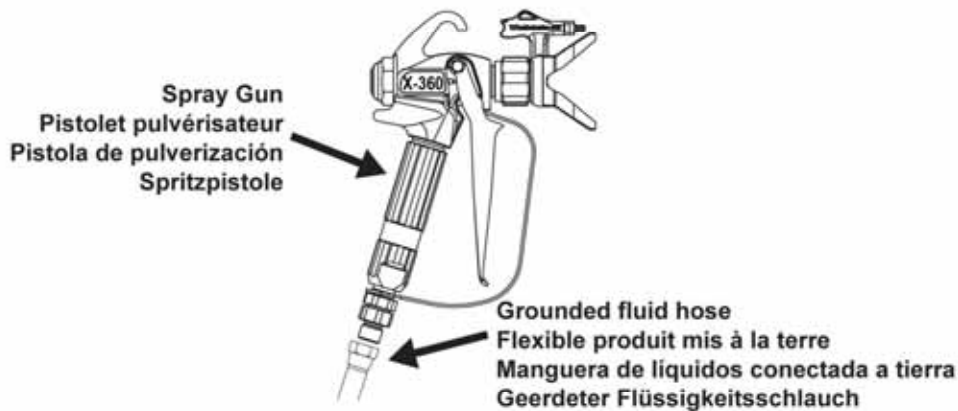

Setup Installation Ajuste Einrichtung

⚠ WARNING

Never attempt to assemble, change, or clean the gun, tip, or tip guard without first relieving pressure from the spray system. Follow the "PRESSURE RELIEF PROCEDURE" in the sprayer's equipment manual.

Ne jamais essayer d'assembler, de remplacer ou de nettoyer le pistolet, la buse, le garde-buse avant d'avoir au préalable décompressé le système de pulvérisation. Suivre la PROCEDURE DE DECOMPRESSION du manuel de l'équipement de pulvérisation.

Jamás intente armar, cambiar o limpiar la pistola, la boquilla o el portaboquillas sin descomprimir primero el sistema de pulverización. Siga las instrucciones del PROCEDIMIENTO DE DESCOMPRESION del manual del pulverizador.

Versuchen Sie niemals die Pistole, die Düse oder den Düsenschutz anzupassen, zu ändern oder zu säubern, ohne vorher den Druck aus dem Spritzsystem zu entlassen. Befolgen Sie den "DRUCKAUSGLEICHLAUF" im Handbuch der Ausrüstung zur Sprühanlage.

⚠ WARNING

Always use tip safety guard for added protection against injection. Beware that the guard alone will not prevent injection. NEVER cut off tip guard! Always engage gun trigger lock when the gun is not in use. Before servicing equipment, consult all equipment manuals and follow all warnings.

Toujours utiliser le garde-buse de sécurité pour une protection accrue contre les injections. Attention : le garde-buse seul ne peut empêcher les injections. NE JAMAIS couper cette garde-buse ! Toujours verrouiller la gâchette à chaque arrêt de la pulvérisation. Avant de procéder à l'entretien de l'équipement, consulter tous les manuels de l'équipement et respecter toutes les mises en garde.

Utilice siempre el protector de seguridad, para una mayor protección contra el peligro de inyección. Tenga cuidado, puesto que no basta con el protector para evitar la inyección. ¡JAMAS corte el portaboquillas! Siempre trabe el seguro del gatillo cuando el pulverizador no se usa. Antes de realizar el mantenimiento del equipo, consulte todos los manuales y respete todas las advertencias.

Verwenden Sie immer den Düsensicherheitsschutz für zusätzlichen Schutz gegen Einspritzung. Seien Sie vorsichtig, denn der Schutz alleine schützt nicht vor Einspritzung. Schlagen Sie NIEMALS den Düsenschutz ab! Aktivieren Sie immer die Pistolenauslösersperre, wenn die Pistole nicht verwendet wird. Bevor Sie die Ausrüstung warten, schlagen Sie in den Ausrüstungshandbüchern nach und befolgen alle Warnungen



Professional Airless Spray Gun

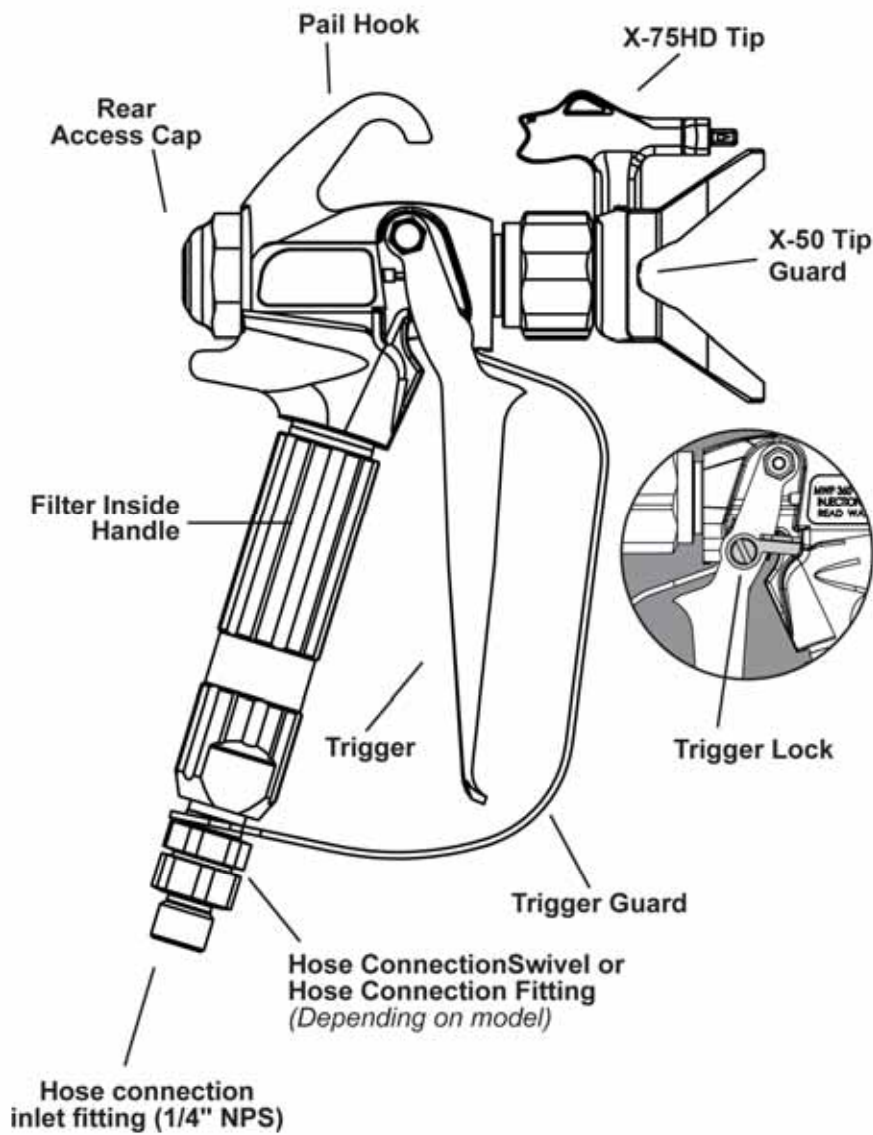

If the spray gun model you own came with the tip included, follow the instructions below to install the guard and tip. If you are using a different tip, follow the installation instructions provided with the tip you are using.

Si votre modèle de pistolet pulvérisateur comporte une buse, suivez les instructions ci-dessous pour installer le garde-buse et la buse. Si vous utilisez une buse différente, suivez les instructions de montage fournies avec la buse que vous utilisez.

Si la pistola de pulverización modelo que ha comprado vino con la boquilla incluida, siga las instrucciones a continuación para instalar el portaboquillas y la boquilla. Si utiliza otra boquilla, siga las instrucciones de instalación que la acompañan.

Wurde das Spritzpistolenmodell, das Ihnen gehört, mit Düse geliefert, befolgen Sie die Anweisungen unten, um den Schutz und die Düse zu installieren. Verwenden Sie eine andere Düse, befolgen Sie die Installationsanweisungen, die mit der Düse bereitgestellt wurden, die Sie verwenden.

Installation of tip and guard

Montage de la buse et du garde-buse

Instalación de la boquilla y el portaboquillas

Spitze- und Schutz-Installation



A. Use seal alignment tool on tip handle to insert seal and pressure gasket into back of guard, turn to align with tip shaft opening.
 B. Insert tip into opening on guard. NOTE: Narrow end of tip handle should be in forward position for spraying.
 Thread the guard onto gun head until it stops. Tighten slightly with wrench - DO NOT OVER TIGHTEN.

A. Utiliser l'outil d'alignement du joint sur la poignée de la buse pour insérer le joint et le joint statique de pression à l'arrière du garde-buse, tourner pour aligner avec l'ouverture de l'arbre de la buse.
 B. Insérer la buse dans l'ouverture sur le garde-buse. REMARQUE : Le collet de la poignée de la buse doit être placé en position avant pour la pulvérisation.
 Faire passer le garde-buse sur la tête du pistolet jusqu'au blocage. Serrer légèrement avec une clé. NE PAS TROP SERRER.

A. Utilice una herramienta de alineación de sello en la empuñadura de la boquilla para introducir el sello y la junta de presión en la parte posterior del protector, gire para alinear con la abertura del eje de la boquilla.
 B. Inserte la boquilla en la abertura del protector de . OBSERVACIÓN: El extremo angosto de la empuñadura de la boquilla debe estar en posición delantera para pulverizar.
 Inserte el protector en el cabezal de la pistola hasta que se detenga. Apriete levemente mediante una llave apropiada; NO APRIETE DEMASIADO.

A. Verwenden Sie das Dichtungsabgleichwerkzeug beim Düsenhalter, um Dichtung und Druckabdichtung auf der Rückseite des Schutzens einzufügen und drehen Sie es um es mit der Achsenöffnung auszurichten.
 B. Fügen Sie die Düse in die Öffnung des ein. HINWEIS: Das schmale Ende des Düsenhalters sollte sich in Vorwärtsstellung für Sprühen befinden.
 Bringen Sie den Schutz auf den Pistolenkopf an, bis er stoppt. Leicht mit Schlüssel anziehen - NICHT ZU STARK ANZIEHEN.

**Spray Gun
 Pistolet pulvérisateur
 Pistola de pulverización
 Spritzpistole**

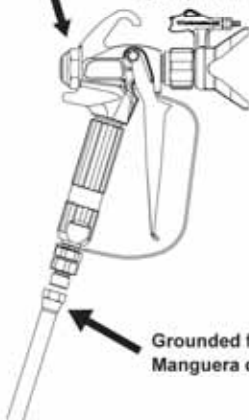

Attach a properly grounded fluid hose to the fluid hose connection fitting on the bottom of the handle of your spray gun. Use two (2) wrenches - one on the gun and one on the hose. Tighten securely.

Raccorder un flexible produit correctement mis à la terre à la fixation du raccord du flexible produit sur le bas de la poignée du pistolet pulvérisateur. Utiliser deux (2) clés : l'une sur le pistolet et l'autre sur le flexible. Bien serrer

Conecte una manguera de líquido debidamente conectada a tierra al dispositivo de conexión de la manguera, en la parte inferior de la empuñadura de la pistola. Utilice dos (2) llaves, una para la pistola y otra en la manguera. Apriete fuerte.

Bringen Sie einen ordentlich geerdeten Flüssigkeitsschlauch an das Flüssigkeitsschlauchverbindungsstück unten am Halter Ihrer Sprühpistole an. Verwenden Sie zwei (2) Schlüssel - einen für die Pistole und einen für den Schlauch. Sicher festziehen.

**Grounded fluid hose - Flexible produit mis à la terre
 Manguera de líquidos conectada a tierra - Geerdeter Flüssigkeitsschlauch**

Trigger Lock Positions Position de la gâchette Posiciones del seguro del gatillo Stellungen Auslösersperre

Locked
Verrouillée
Bloqueado
Gesperrt



Unlocked
Déverrouillée
Desbloqueado
Entsperrt



Operation Fonctionnement Operación Betrieb

1. Make sure your tip is in the spray position.
2. Start your sprayer following the instructions provided in the equipment owner's manual.
3. Adjust the fluid pressure on the sprayer until proper atomization is achieved. Always spray at the lowest pressure necessary to get the desired atomization.

1. S'assurer que la buse est en position de pulvérisation.
2. Démarrer le pulvérisateur en suivant les instructions fournies dans le manuel d'utilisateur de l'équipement.
3. Ajuster la pression du fluide sur le pulvérisateur jusqu'à obtention d'une pulvérisation appropriée. Toujours pulvériser à la pression inférieure nécessaire pour obtenir la pulvérisation souhaitée.

1. Asegúrese de que la boquilla está en la posición de pulverización.
2. Comience a pulverizar conforme a las instrucciones que se incluyen en el manual del usuario del equipo.
3. Regula la presión del líquido de la pistola hasta alcanzar una adecuada atomización. Siempre trabaje a la mínima presión necesaria para obtener la pulverización deseada.

1. Stellen Sie sicher, dass sich Ihre Düse in der Sprühstellung befindet.
2. Starten Sie Ihre Sprühanlage entsprechend den Anweisungen, die Sie im Handbuch zur Ausrüstung befinden.
3. Passen Sie den Flüssigkeitsdruck in der Sprühanlage an, bis die gewünschte Zerstäubung erreicht ist. Sprühen Sie immer mit dem geringsten notwendigen Druck, um die gewünschte Zerstäubung zu erreichen.

Tip Clogs Déboucher la buse Obstrucción de la boquilla Verstopfungen der Düse

If you are using a _____ tip, follow the instructions on the next page to clear a clogged tip. If you are using a different tip, follow the instructions included in the equipment manual provided with that tip.

Si vous utilisez une buse _____, suivez les instructions de la page suivante pour déboucher une buse. Si vous utilisez une buse différente, suivez les instructions incluses dans le manuel de l'équipement fourni avec cette buse.

Si utiliza una boquilla _____, siga las instrucciones de la página siguiente, para desobstruir una boquilla tapada. Si utiliza otra boquilla, siga las instrucciones del manual del equipo que la acompaña.

Verwenden Sie eine _____-Düse, befolgen Sie die Anweisungen auf der nächsten Seite um eine verstopfte Düse zu säubern. Verwenden Sie eine andere Düse, befolgen Sie die Anweisungen, die Sie im Ausrüstungshandbuch vorfinden, das Ihnen mit der Düse ausgeliefert wurde.

Tip Clogs

Déboucher la buse

Obstrucción de la boquilla

Verstopfungen der Düse

1. Engage trigger Lock. Rotate tip handle 180° to the reverse position.
 2. Unlock trigger. Point the gun into a bucket holding the gun away from you. Trigger the gun briefly to expel the clog.
 3. Engage trigger Lock. Rotate tip handle 180° to the spray position.
 4. Unlock trigger. Spray a test to be sure the clog is completely expelled.
- NOTE: If clog is not completely expelled after following the above steps, repeat steps 1-4 until the clog is completely cleared.

1. Verrouiller la gâchette. Tourner la poignée de la buse à 180°.
 2. Déverrouiller la gâchette. Pointer le pistolet dans un seau à bonne distance de votre corps. Actionner le pistolet brièvement pour déboucher.
 3. Verrouiller la gâchette. Tourner la poignée de la buse à 180° dans la position de pulvérisation.
 4. Déverrouiller la gâchette. Faire un test de pulvérisation pour s'assurer que le bouchon est totalement expulsé.
- REMARQUE : si le bouchon n'est pas entièrement expulsé après avoir suivi les étapes ci-dessus, répéter les étapes 1-4 jusqu'à déblocage total.

Locked
Verrouillé
Bloqueado
Gesperrt



1. Trabe el seguro del gatillo. Gire la empuñadura de la boquilla 180° hasta la posición inversa.
 2. Destrabe el gatillo. Apunte la pistola hacia el interior de un cubo (balde), manteniendo la pistola alejada del cuerpo. Dispare brevemente la pistola para expulsar la obstrucción.
 3. Trabe el seguro del gatillo. Gire la empuñadura de la boquilla 180° hasta la posición de pulverización.
 4. Destrabe el gatillo. Haga una pulverización de prueba para asegurarse de haber eliminado completamente la obstrucción.
- OBSERVACIÓN: Si después de seguir los pasos anteriores la boquilla sigue parcialmente obstruida, repita las etapas 1 a 4 hasta eliminar por completo la obstrucción.

1. Auslösersperre aktivieren. Drehen Sie den Düsenhalter um 180° auf die Gegenposition.
 2. Entsperrern Sie den Auslöser. Richten Sie die Pistole in einen Eimer und halten Sie die Pistole von sich selbst weg. Lösen Sie die Pistole leicht aus, um die Verstopfung auszustoßen.
 3. Auslösersperre aktivieren. Drehen Sie den Düsenhalter um 180° auf die Sprühposition.
 4. Entsperrern Sie den Auslöser. Führen Sie einen Sprühtest durch, um sicherzustellen, dass die Verstopfung vollständig entfernt wurde.
- HINWEIS: Ist die Verstopfung nach Durchführung obiger Schritte nicht vollständig entfernt, wiederholen Sie die Schritte 1 - 4, bis die Verstopfung vollständig entfernt ist.

Seal Removal

Démonter le joint

Extracción del sello

Entfernung der Dichtung

Follow the pressure relief procedure as instructed in your equipment owner's manual. Engage trigger lock. Remove guard from gun head. Push seal and gasket out rear of guard using narrow end of tip handle.

Suivre la procédure de décompression comme indiqué dans le manuel d'utilisateur. Verrouiller la gâchette. Démonter la garde de la tête du pistolet. Sortir le joint et le joint statique de l'arrière de la garde en utilisant le collet de la poignée de la buse. Siga el procedimiento de la relevación de presión.

Siga las instrucciones de descompresión que se incluyen en el manual del usuario del equipo. Trabe el seguro del gatillo. Retire el protector del cabezal de la pistola. Extraiga el sello y la junta de la parte posterior del protector utilizando el extremo angosto de la empuñadura de la boquilla.

Befolgen Sie den Druckausgleichablauf wie im Handbuch zur Ausrüstung angegeben. Auslösersperre aktivieren. Schutz vom Pistolenkopf entfernen. Drücken Sie die Dichtung und Abdichtung hinten aus dem Schutz heraus, indem Sie das schmale Ende des Düsenhalters verwenden.

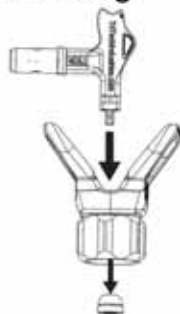

Filter Cleaning and Replacement Nettoyage et remplacement du filtre Limpieza y cambio de filtro Filter säubern und ersetzen

Filter Removal
Démonter
le filtre
Extracción
del filtro
Filter entfernen



IMPORTANT! YOU MUST RELIEVE ALL FLUID PRESSURE FROM YOUR ENTIRE SPRAY SYSTEM INCLUDING THE SPRAYER, HOSE AND GUN BEFORE DISCONNECTING THE HOSE! Turn off your sprayer and follow the pressure relief procedure as instructed in your equipment owner's manual. Engage trigger lock. Disconnect the hose from the connection at the bottom of your gun.

IMPORTANT ! ENLEVER OBLIGATOIREMENT TOUTE LA PRESSION LIQUIDE DE L'ENSEMBLE DU SYSTEME DE PULVERISATION Y COMPRIS DU PULVERISATEUR, DU FLEXIBLE ET DU PISTOLET AVANT DE DEMONTER LE FLEXIBLE ! Fermer le pulvérisateur et suivre la procédure de décompression comme indiqué dans le manuel d'utilisateur. Verrouiller la gâchette. Désolidariser le flexible du raccord situé en bas du pistolet.

IMPORTANTE: ¡ANTES DE DESCONECTAR LA MANGUERA, ES PRECISO LIBERAR TODA LA PRESIÓN DEL LÍQUIDO EN TODO EL SISTEMA DE PULVERIZACIÓN, INCLUIDO EL PULVERIZADOR, LA MANGUERA Y LA PISTOLA! Desactive el pulverizador y siga las instrucciones de descompresión que se incluyen en el manual del usuario del equipo. Trabe el seguro del gatillo. Desconecte la manguera de la conexión en la parte inferior de la pistola.

WICHTIG! SIE MÜSSEN DEN GESAMTEN FLÜSSIGKEITSDRUCK AUS DEM GESAMTEN SPRÜHSYSTEM, EINSCHLIESSLICH DER SPRÜHANLAGE, DES SCHLAUCHS UND DER PISTOLE ENTFERNEN, BEVOR SIE DEN SCHLAUCH ENTFERNEN! Schalten Sie Ihre Sprühanlage aus und befolgen Sie den Druckausgleichablauf wie im Handbuch zur Ausrüstung angegeben. Auslösersperre aktivieren. Trennen Sie den Schlauch von der Verbindung unten an Ihrer Pistole.

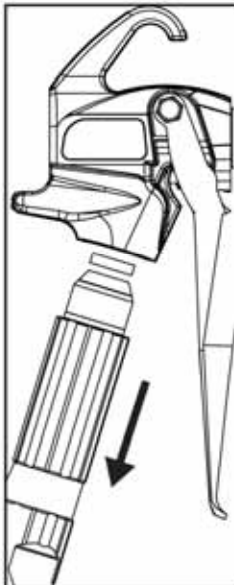

Disconnect fluid hose from base of gun. Using a 3/4" or 19mm wrench or an adjustable wrench, unscrew and remove the handle from the head of the gun using the flat areas at the base of the handle. Be sure to retain the white nylon gasket between the gun handle and gun head.

Disconnect fluid hose from base of gun. Using a 3/4" or 19mm wrench or an adjustable wrench, unscrew and remove the handle from the head of the gun using the flat areas at the base of the handle. Be sure to retain the white nylon gasket between the gun handle and gun head.

Disconnect fluid hose from base of gun. Using a 3/4" or 19mm wrench or an adjustable wrench, unscrew and remove the handle from the head of the gun using the flat areas at the base of the handle. Be sure to retain the white nylon gasket between the gun handle and gun head.

Disconnect fluid hose from base of gun. Using a 3/4" or 19mm wrench or an adjustable wrench, unscrew and remove the handle from the head of the gun using the flat areas at the base of the handle. Be sure to retain the white nylon gasket between the gun handle and gun head.

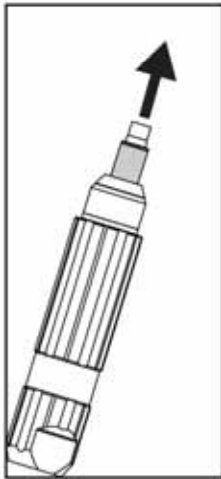

Remove filter from top of gun handle - be sure to retain the spring inside the gun handle. Clean and flush the inside of the gun handle. Insert spring into gun handle then install new (or cleaned) filter with the closed end down into the gun handle. Place white nylon gasket on top of gun handle and thread onto gun head. Tighten securely with 3/4" or 19mm wrench or adjustable wrench using the flat areas at the base of the handle.

NOTE: Use only original replacement parts and filters in order to keep your gun in top operating condition and maintain your warranty coverage. Use of aftermarket or non- parts will void your warranty.

Faire sortir le filtre du bas de la poignée du pistolet. Nettoyer et rincer les traces de produit de la poignée du pistolet. Installer un nouveau filtre avec l'extrémité ouverte du filtre dans la poignée du pistolet d'abord. Raccorder la fixation de raccord du flexible. S'assurer que le ressort est bien à l'intérieur de la fixation du raccord du flexible. Bien serrer avec une clé 13/16" ou 21 mm ou une clé à molette. Raccorder le flexible produit.

REMARQUE : n'utiliser que des pièces de rechange originales afin de garder le pistolet dans des conditions optimales de fonctionnement et de conserver votre garantie. L'utilisation de pièces de rechange autres que annulera votre garantie.

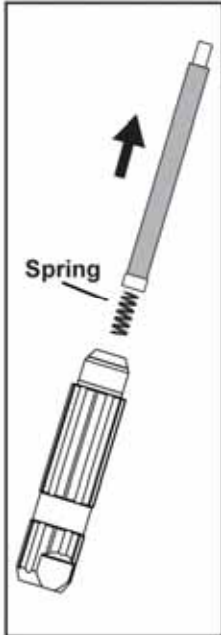

Deslice el filtro hacia fuera de la parte inferior de la empuñadura de la pistola. Limpie y lave el interior de los conductos de líquidos de la empuñadura de la pistola. Instale en la empuñadura de la pistola un filtro nuevo, primero con su extremo abierto. Reconecte el accesorio de conexión de la manguera. Asegúrese de que el resorte esté dentro del accesorio de conexión de la manguera. Apriete bien con una llave de 13/16" o 21 mm o con una llave ajustable. Reconecte la manguera de líquidos.

OBSERVACIÓN: Utilice únicamente piezas de repuesto y filtros originales de , para mantener la pistola en el mejor estado de funcionamiento posible y asegurar la cobertura de garantía. La utilización de piezas no fabricadas por anulará la garantía.

Ziehen Sie den Filter vom Boden der Pistolenhalterung heraus. Säubern Sie die innen liegenden Flüssigkeitsdurchläufe der Pistolenhalterung und spülen Sie sie durch. Bringen Sie den neuen Filter mit dem offenen Ende des Filters zuerst in die Pistolenhalterung ein. Bringen Sie die Schlauchverbindung wieder an. Stellen Sie sicher, dass die Feder in der Schlauchverbindung ist. Ziehen Sie sie fest mit einem 13/16"- oder 21mm-Schlüssel oder einem verstellbaren Schlüssel an. Flüssigkeitsschlauch wieder anschließen.

HINWEIS: Verwenden Sie nur Originalersatzteile und Filter, um beste Betriebsbedingungen für Ihre Pistole zu gewährleisten und um Ihre Garantieabdeckung nicht zu verlieren. Verwenden Sie Teile aus Ersatzteilmärkten oder keine -Teile, verlieren Sie Ihre Garantie.



Original Replacement Filters

Part No.	Mesh	Color
AX/W0034377	50	White
AX/W0043235	100	Yellow
AX/W0034383	200	Red

⚠ WARNING

Cleaning with Solvents

Nettoyage avec solvants

Limpieza con solventes

Reinigung mit Lösungsmitteln



- Always flush gun outside if possible and at least 25' - 7.5m away from sprayer.
- Area must be free of flammable vapors.
- Always flush at minimum pressure. Always remove tip and guard.
- Static electricity buildup may result in fire or explosion in the presence of flammable vapors.
- Always hold the gun firmly against a grounded, metal container when flushing.
- Toujours rincer le pistolet à l'extérieur si possible et au moins à 25' (7,5 m) du pulvérisateur.
- La zone ne doit pas contenir de vapeurs inflammables.
- Toujours rincer à une pression minimale. Toujours enlever la buse et la garde.
- La formation d'électricité statique peut provoquer un incendie ou une explosion en présence de vapeurs inflammables.
- Pendant le rinçage, toujours maintenir le pistolet fermement contre un conteneur métallique relié à la terre.
- Siempre que sea posible, lave la pistola al aire libre y por lo menos a una distancia 7,5 metros del pulverizador.
- El área debe estar exenta de vapores inflamables.
- Siempre lave a la presión mínima. Quite siempre la boquilla y el protector.
- La acumulación de electricidad estática podría causar incendio o explosión en presencia de vapores inflamables.
- Al lavar, sujete siempre firmemente la pistola contra un recipiente metálico conectado a tierra.
- Wenn möglich spülen Sie die Pistole immer außerhalb und in einer Entfernung von wenigstens 25' - 7,5m vom Sprühgerät aus.
- Der Bereich muss frei von entflammabaren Dämpfen sein.
- Spülen Sie immer bei minimalem Druck aus. Entfernen Sie immer Düse und Schutz.
- Aufbau statischer Elektrizität kann zu Feuer oder Explosion führen beim Vorhandensein von entflammabaren Dämpfen.
- Halten Sie die Pistole beim Durchspülen fest gegen einen geerdeten, metallischen Behälter.

Replacing the valve stem assembly Remplacement de l'unité de la tige de vanne Cambio del conjunto de vástago de válvula Ersetzung der Ventilschaftanordnung

Locked
Verrouillée
Bloqueado
Gesperrt



Relieve fluid pressure from your entire spray system. Engage trigger lock and disconnect fluid hose from gun. Remove tip and guard.

Décompresser l'ensemble du système de pulvérisation. Verrouiller la gâchette et déconnecter le flexible produit du pistolet. Enlever la buse et la garde.

Realice la descompresión de todo el sistema de pulverización. Trabe el seguro del gatillo y desconecte de la pistola la manguera de líquidos. Retire la boquilla y el protector.

Lassen Sie den Flüssigkeitsdruck aus Ihrem gesamten Sprühsystem ab. Aktivieren Sie die Auslösersperre und trennen Sie den Flüssigkeitsschlauch von der Pistole. Entfernen Sie Düse und Schutz.



Unlock and engage trigger - then: 1. Unscrew and remove diffuser from the front of the gun. 2. Release trigger and unscrew and remove end cap from back of gun head and remove the spring from the cavity.

Déverrouiller et verrouiller la gâchette. Puis, 1. dévisser et enlever le diffuseur de la partie avant du pistolet. 2. Relâcher la gâchette et dévisser et enlever le bouchon de protection de l'arrière de la tête du pistolet et sortir le ressort de sa cavité.

Desbloquee y trabe el gatillo y luego: 1. Desenrosque y retire el difusor de la parte delantera de la pistola. 2. Suelte el gatillo y desenrosque y retire el capuchón de la parte posterior del cabezal de la pistola y extraiga el resorte de la cavidad.

Entsperren und aktivieren Sie den Auslöser - dann: 1. Schrauben Sie den Diffusor ab und entfernen Sie ihn von der Vorderseite der Pistole. 2. Lassen Sie den Auslöser los und schrauben Sie die Abschlusskappe vom Hinterteil des Pistolenkopfs ab und ziehen Sie die Feder aus der Aushöhlung.



1. Use long nose pliers to hold front of valve stem - then 2. unscrew and remove retractor knob from the inside of the back of the gun head. 3. Unscrew and remove seal housing from the back of the gun head using a 5/16" or 8mm socket.

1. Utilisez les longues pinces de nez pour tenir l'avant de la tige de valve - puis. 2. Utiliser un outil de jointage fourni avec le kit de réparation pour maintenir l'avant de la tige de vanne, puis dévisser et enlever le logement de joint à l'arrière de la tête du pistolet au moyen d'une douille 8mm ou 5/16".

1. Utilice los alicates largos de la nariz para llevar a cabo el frente del vástago de válvula - entonces. 2. Utilice la herramienta de sellado suministrada con el kit de reparación para sujetar el vástago de válvula. Desenrosque y retire el alojamiento del sello de la parte posterior del cabezal de la pistola mediante un adaptador de 8mm o 5/16".

1. Benutzen Sie lange Nase Zangen, um Frontseite des Ventilschafts zu halten - dann. 2. Verwenden Sie das Dichtungswerkzeug aus dem Reparatur-Set, um den Vorderteil des Ventilschafts zu halten - schrauben Sie dann das Dichtungsgehäuse vom hinteren Teil des Pistolenkopfs ab und entfernen Sie ihn unter Verwendung 8mm - oder 5/16" Muffe.



Clean and flush the fluid passages of the gun. DO NOT use a sharp object to do this. Only use a soft brush or rag.

Nettoyer et rincer les traces de produit du pistolet. NE PAS utiliser d'objet pointu pour cette opération. N'utiliser qu'une brosse ou un chiffon tendre.

Limpie y lave los conductos de líquidos de la pistola. NO utilice objetos afilados para hacerlo, sino únicamente un cepillo suave o un trapo.

Säubern Sie die Flüssigkeitsdurchläufe der Pistolenhalterung und spülen Sie sie durch. Verwenden Sie KEINEN scharfen Gegenstand, um dies zu tun. Verwenden Sie nur eine weiche Bürste oder einen Lappen.



Apply grease to the o-ring on the new seal housing. **Use ONLY nonsilicon grease.**

Appliquez de la graisse sur le joint torique du nouveau logement de joint. **N'UTILISER que de la graisse sans silicone.**

Aplique grasa en la junta tórica del nuevo alojamiento del sello. **Utilice ÚNICAMENTE grasa sin siliconas.**

Bringen Sie Schmierfett auf den O-Ring auf dem neuen Dichtungsgehäuse an. **Verwenden Sie NUR Schmierfett ohne Silikon.**



1. Insert new seal housing and valve stem into the rear of the gun. Thread the seal housing in (clockwise) until it stops. Tighten with 9/16" or 14mm socket - **DO NOT OVERTIGHTEN.** 2. While holding front of valve stem with long nose pliers - 3. thread the new retractor knob onto the end of the valve stem from the back of the gun and tighten **by hand** until it stops. **DO NOT USE TOOLS TO TIGHTEN KNOB - DO NOT OVERTIGHTEN.**

Insérer le nouveau logement de joint et la tige de vanne à l'arrière du pistolet. Guider le logement de joint (dans le sens des aiguilles d'une montre) jusqu'au blocage. Serrer avec une douille 9/16" ou 14 mm. **NE PAS TROP SERRER.** Tout en tenant l'avant de la tige de valve avec de longues pinces de nez, faire passer le nouveau bouton du rétracteur sur l'extrémité de la tige de vanne à l'arrière du pistolet et serrer jusqu'au blocage.

Inserte en la parte posterior de la pistola el nuevo alojamiento de sello y el vástago de válvula. Introduzca el alojamiento de sello en el sentido horario, hasta que se detenga. Apriete con un adaptador de 9/16" o 14 mm: **NO APRIETE DEMASIADO.** Mientras que lleva a cabo el frente del vástago de válvula con los alicates largos de la nariz, introduzca la nueva perilla de retractor en el extremo del vástago de la parte posterior de la pistola y apriete hasta que se detenga.

1. Setzen Sie ein neues Dichtungsgehäuse mit Ventilschaft an der Rückseite der Pistole ein. Schrauben Sie das Dichtungsgehäuse im Uhrzeigersinn ein bis zum Anschlag. Ziehen Sie das Gehäuse mit einem 14-er Gabelschlüssel an. **Achtung: Nicht überdrehen !!**
 2. + 3. Während Sie das vordere Teil des Ventilschaftes mit einer Zange festhalten, schrauben Sie eine neue Spannschraube auf das hintere Teil des Ventilschaftes und ziehen Sie diese von Hand bis zum Anschlag an. **Benutzen Sie dafür kein Werkzeug und überdrehen Sie diese Schraube nicht.**



1. Insert new retractor spring into back of gun. Thread end cap onto back of gun and tighten securely. Engage trigger, then 2. thread new diffuser on to front of gun and tighten securely while keeping trigger engaged.

Insérer le nouveau ressort du rétracteur dans l'arrière du pistolet. Faire passer le bouchon de protection sur l'arrière du pistolet et bien serrer. Verrouiller la gâchette, puis faire passer le nouveau diffuseur sur l'avant du pistolet et bien serrer tout en gardant la gâchette verrouillée.

Inserte el nuevo resorte retractor en la parte posterior de la pistola. Introduzca el capuchón en la parte posterior de la pistola y ciérrelo bien. Trabe el gatillo, introduzca el nuevo difusor en la parte frontal de la pistola y ciérrelo bien manteniendo trabado el gatillo.

Führen Sie eine neue Retraktorfeder in die Rückseite der Pistole ein. Bringen Sie die Abschlussklappe auf die Rückseite der Pistole an und ziehen Sie sie fest an. Aktivieren Sie den Auslöser, bringen Sie dann den neuen Diffusor auf die Vorderseite der Pistole an und ziehen Sie ihn fest an, während Sie den Auslöser aktiviert halten.



Parts Drawing for your X-360 Spray Gun
Schémas des pièces pour le Pistolet Pulvérisateur X-360
Diagrama de piezas de la pistola de pulverización X-360
Teilezeichnung für Ihre X-360 Spritzpistole

Parts List:

Item	Part#	Description	Quantity
1	Included in #5	Diffuser	1
2	Included in #5	Valve/Seal Assy.	1
3	Included in #5	Knob, Retractor	1
4	Included in #5	Spring, Seal Assy.	1
5	AX/02-360-500	KIT, Repair - (Parts 1-4)	
6	AX/02-360-501	Head, 7/8"	1
	AX/02-360-502	Head, 11/16"	
7	AX/02-360-503	Pins, Trigger	2
8	AX/02-360-504	Cap, Rear	1
9	AX/02-360-505	Shaft, Trigger	1
10	AX/02-360-506	Nut, Trigger Shaft	1
11	AX/02-360-507	Trigger Assy., 4-Finger	1
	AX/02-360-508	Trigger Assy., 2-Finger	
12	AX/02-360-509	Seal, Handle	1
13	AX/W0034377	Filter, 50 Mesh	1
14	AX/02-360-510	Spring, Filter	1
15	AX/02-360-511	Handle	1
16	AX/01-300-000	Guard Trigger	1
17	AX/02-360-513	Swivel 1/4" Hose Connection	1

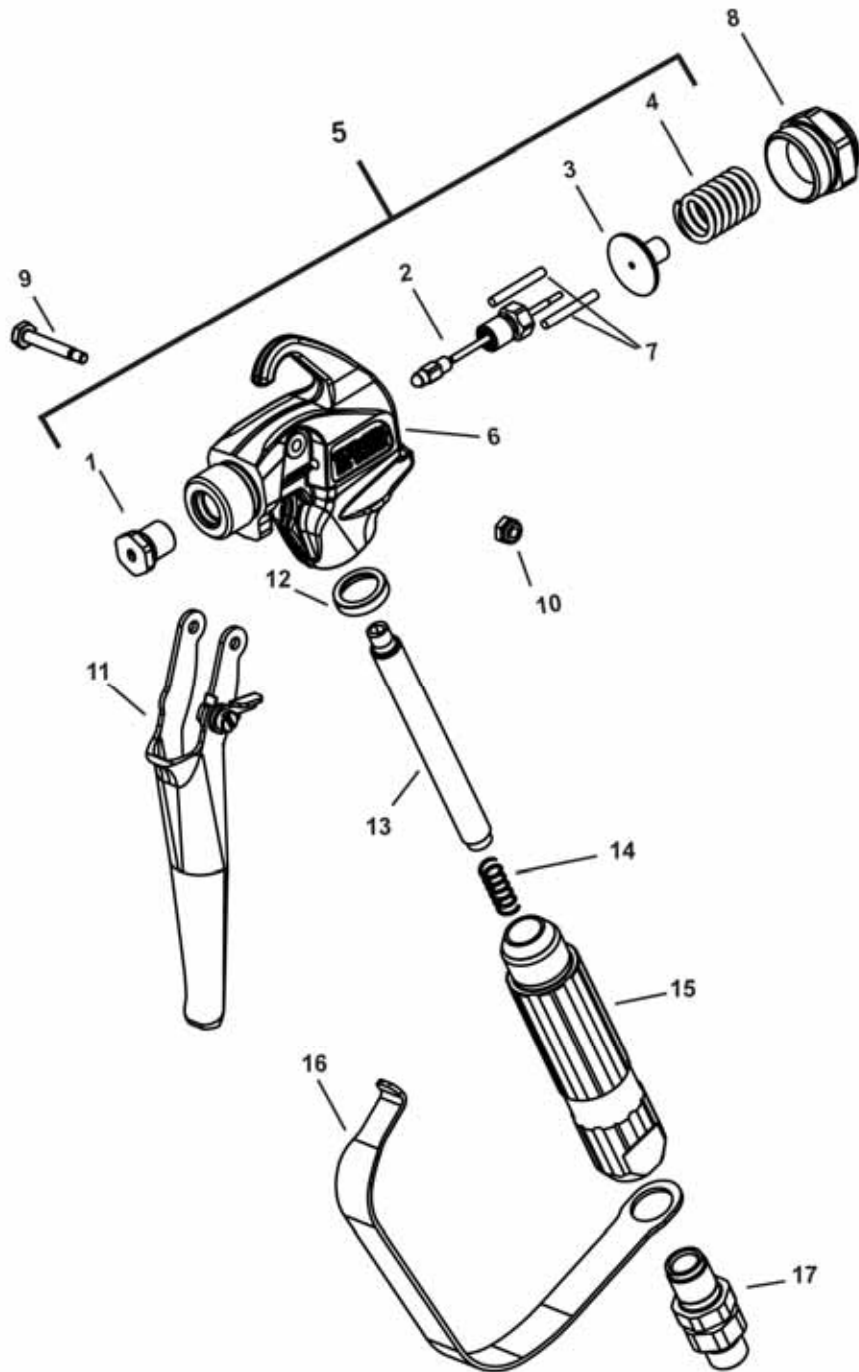

Parts Drawing for your X-75HD Spray Tip and Guard
Schémas des pièces pour l Buse et le garde-buse
du Pulvérisateur X-75HD
Diagrama de piezas de la boquilla y portaboquillas X-75HD
Teilezeichnung für Ihre X-75HD Spritzdüse und Schutz

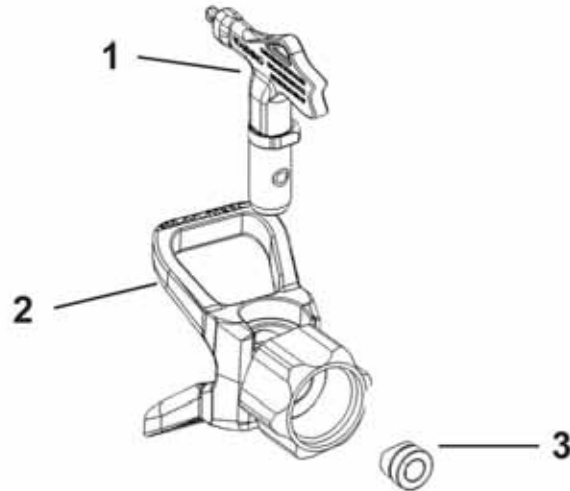

Parts List:

Item	Part#	Description	Quantity
1	AX/01-200-XXX	X-75HD Reversible Tip	1
2	AX/01-300-000	X-50 5000psi Tip Guard 7/8"	1
	AX/01-300-001	X-50 5000psi Tip Guard 11/16"	1
3	AX/01-100-000	X Series Tip + Seal Gasket	1



Technical Data for your X-360 Spray Gun
Données techniques pour le Pistolet Pulvérisateur X-360
Información técnica de la pistola de pulverización X-360
Technische Daten für Ihre X-360 Spritzpistole

Maximum Working Pressure.....	3600 PSI (250 bar, 24.5 Mpa)
Weight	15.2 oz. (431 g)
Hose Inlet Connection.....	1/4 in NPSM Swivel
Wetted Parts.....	Stainless steel, polyethylene, nylon, aluminum, tungsten carbide



LIMITED WARRANTY

ATOMEX warrants that at the time of original receipt, purchase and/or delivery to the original purchaser for use, the product(s) covered by this warranty is/are free from defects in the material and workmanship in its manufacture. With the exception of any special, limited, or extended warranty published by ATOMEX, ATOMEX's obligation under this warranty is limited to repairing without charge or replacing those parts which, to ATOMEX's reasonable satisfaction, are shown to be defective within twelve (12) months after sale to the original purchaser. This warranty applies only when the product is installed and operated in accordance with the instructions of ATOMEX.

This warranty does not apply in the case of damage or wear caused by abrasion, corrosion or misuse, negligence, accident, faulty installation, substitution of non-ATOMEX component parts, or tampering with the product in a manner that will or has impair(ed) normal operation.

Defective parts must to be returned to an authorized sales or service company or ATOMEX. All transportation and/or shipping charges, including return to the factory, if necessary, are the responsibility of the original purchaser. Repaired or replaced products will be returned to the original purchaser with transportation and/or shipping charges prepaid by ATOMEX.

THERE IS NO OTHER EXPRESSED WARRANTY. ATOMEX HEREBY DISCLAIMS ANY AND ALL IMPLIED WARRANTIES INCLUDING, BUT NOT LIMITED TO, THOSE OF MERCHANTABILITY AND FITNESS FOR A PARTICULAR PURPOSE, TO THE EXTENT PERMITTED BY LAW. THE DURATION OF ANY IMPLIED WARRANTIES WHICH CANNOT BE DISCLAIMED IS LIMITED TO THE TIME PERIOD SPECIFIED IN THE EXPRESS WARRANTY. IN NO CASE SHALL ATOMEX'S LIABILITY EXCEED THE AMOUNT OF THE PURCHASE PRICE. LIABILITY FOR CONSEQUENTIAL, INCIDENTAL OR SPECIAL DAMAGES UNDER ANY AND ALL WARRANTIES IS EXCLUDED TO THE EXTENT PERMITTED BY LAW.

All data and information, both written and visual, communicated in the manual represents the current and latest information available at the time this document was printed or posted. ATOMEX, Incorporated reserves the right to make changes and update information at any time and without notice.



ATOMEX
29 Carlingford Street
Regents Park NSW 2143
Phone: (02) 9644 1040
Fax: (02) 9644 3147
Email: info@atomex.com.au
www.atomex.com.au





INTRODUCTION

Thank you for purchasing a Honda engine. We want to help you to get the best results from your new engine and to operate it safely. This manual contains information on how to do that; please read it carefully before operating the engine. If a problem should arise, or if you have any questions about your engine, consult an authorized Honda servicing dealer.

All information in this publication is based on the latest product information available at the time of printing. Honda Motor Co., Ltd. reserves the right to make changes at any time without notice and without incurring any obligation. No part of this publication may be reproduced without written permission.

This manual should be considered a permanent part of the engine and should remain with the engine if resold.

Review the instructions provided with the equipment powered by this engine for any additional information regarding engine startup, shutdown, operation, adjustments or any special maintenance instructions.

United States, Puerto Rico, and U.S. Virgin Islands:
We suggest you read the warranty policy to fully understand its coverage and your responsibilities of ownership. The warranty policy is a separate document that should have been given to you by your dealer.

SAFETY MESSAGES

Your safety and the safety of others are very important. We have provided important safety messages in this manual and on the engine. Please read these messages carefully.

A safety message alerts you to potential hazards that could hurt you or others. Each safety message is preceded by a safety alert symbol **▲** and one of three words, DANGER, WARNING, or CAUTION.

These signal words mean:

▲ DANGER You WILL be KILLED or SERIOUSLY HURT if you don't follow instructions.

▲ WARNING You CAN be KILLED or SERIOUSLY HURT if you don't follow instructions.

▲ CAUTION You CAN be HURT if you don't follow instructions.

Each message tells you what the hazard is, what can happen, and what you can do to avoid or reduce injury.

DAMAGE PREVENTION MESSAGES

You will also see other important messages that are preceded by the word NOTICE.

This word means:

NOTICE Your engine or other property can be damaged if you don't follow instructions.

The purpose of these messages is to help prevent damage to your engine, other property, or the environment.

© 2006 Honda Motor Co., Ltd. — All Rights Reserved

37Z4H604
00X37-Z4H-6040

GX120UT1-GX160UT1-GX200UT
59000.2007.01
PRINTED IN THAILAND

HONDA

OWNER'S MANUAL MANUEL DE L'UTILISATEUR MANUAL DEL PROPIETARIO

GX120 · GX160 · GX200

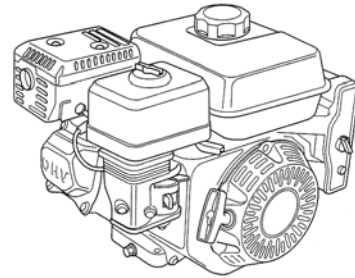

▲ WARNING: ▲

The engine exhaust from this product contains chemicals known to the State of California to cause cancer, birth defects or other reproductive harm.

CONTENTS

INTRODUCTION.....1	SEDIMENT CUP.....12
SAFETY MESSAGES.....1	SPARK PLUG.....12
SAFETY INFORMATION.....2	SPARK ARRESTER.....13
SAFETY LABEL LOCATION.....2	IDLE SPEED.....13
COMPONENT & CONTROL LOCATION.....2	HELPFUL TIPS & SUGGESTIONS.....13
FEATURES.....3	STORING YOUR ENGINE.....13
BEFORE OPERATION CHECKS.....3	TRANSPORTING.....14
OPERATION.....4	TAKING CARE OF UNEXPECTED PROBLEMS.....15
SAFE OPERATING PRECAUTIONS.....4	FUSE REPLACEMENT.....15
STARTING THE ENGINE.....4	TECHNICAL INFORMATION.....16
STOPPING THE ENGINE.....5	Serial Number Location.....16
SETTING ENGINE SPEED.....6	Battery Connections for Electric Starter.....16
SERVICING YOUR ENGINE.....7	Remote Control Linkage.....16
THE IMPORTANCE OF MAINTENANCE.....7	Carburetor Modifications for High Altitude Operation.....17
MAINTENANCE SAFETY.....7	Emission Control System Information.....17
SAFETY PRECAUTIONS.....7	Air Index.....18
MAINTENANCE SCHEDULE.....7	Specifications.....18
REFUELING.....8	Tuneup Specifications.....18
ENGINE OIL.....8	Quick Reference Information.....19
Recommended Oil.....8	Wiring Diagrams.....19
Oil Level Check.....9	CONSUMER INFORMATION.....20
Oil Change.....9	Distributor/Dealer Locator Information.....20
REDUCTION CASE OIL.....9	Customer Service Information.....20
Recommended Oil.....9	
Oil Level Check.....9	
Oil Change.....10	
AIR CLEANER.....10	
Inspection.....10	
Cleaning.....11	

SAFETY INFORMATION

- Understand the operation of all controls and learn how to stop the engine quickly in case of emergency. Make sure the operator receives adequate instruction before operating the equipment.
- Do not allow children to operate the engine. Keep children and pets away from the area of operation.
- Your engine's exhaust contains poisonous carbon monoxide. Do not run the engine without adequate ventilation, and never run the engine indoors.
- The engine and exhaust become very hot during operation. Keep the engine at least 1 meter (3 feet) away from buildings and other equipment during operation. Keep flammable materials away, and do not place anything on the engine while it is running.

SAFETY LABEL LOCATION

This label warns you of potential hazards that can cause serious injury. Read it carefully. If the label comes off or becomes hard to read, contact your Honda dealer for replacement.



* For Canadian types only: French label comes with the engine.

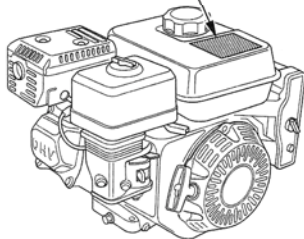

Gasoline is highly flammable and explosive. Turn engine off and let cool before refueling.



The engine emits toxic poisonous carbon monoxide gas. Do not run in an enclosed area.



Read Owner's Manual before operation.

COMPONENT & CONTROL LOCATION

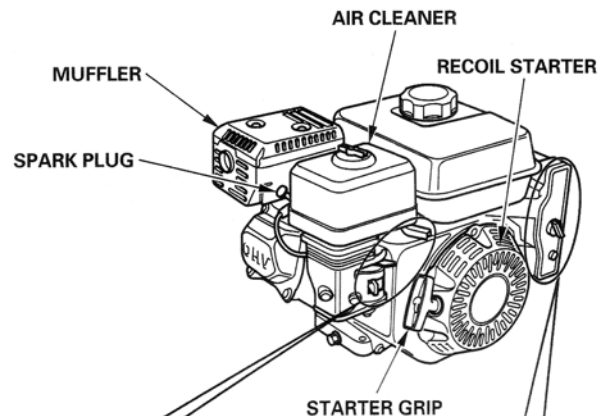
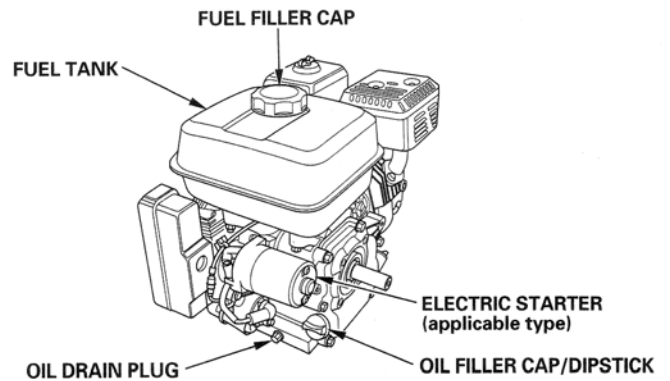

ENGINE CONTROL TYPES

FUEL VALVE LEVER

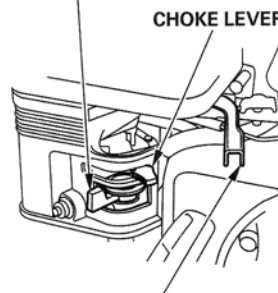

THROTTLE LEVER



CHOKE LEVER (air cleaner low profile type)

EXCEPT ELECTRIC STARTER TYPES

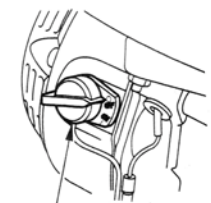

ENGINE SWITCH

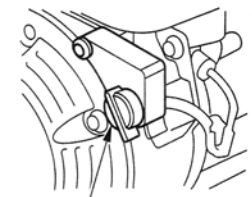

ENGINE SWITCH ELECTRIC STARTER TYPES

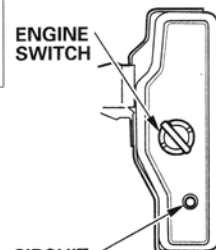

ENGINE SWITCH

CIRCUIT PROTECTOR

FEATURES

OIL ALERT® SYSTEM (applicable types)

The Oil Alert system is designed to prevent engine damage caused by an insufficient amount of oil in the crankcase. Before the oil level in the crankcase can fall below a safe limit, the Oil Alert system will automatically stop the engine (the engine switch will remain in the ON position).

If the engine stops and will not restart, check the engine oil level (see page 9) before troubleshooting in other areas.

CIRCUIT PROTECTOR (applicable types)

The circuit protector protects the battery charging circuit. A short circuit, or a battery connected with reverse polarity, will trip the circuit protector.

The green indicator inside the circuit protector will pop out to show that the circuit protector has switched off. If this occurs, determine the cause of the problem, and correct it before resetting the circuit protector.

Push the circuit protector button to reset.

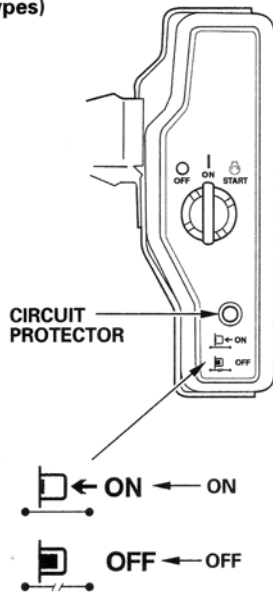

BEFORE OPERATION CHECKS

IS YOUR ENGINE READY TO GO?

For your safety, and to maximize the service life of your equipment, it is very important to take a few moments before you operate the engine to check its condition. Be sure to take care of any problem you find, or have your servicing dealer correct it, before you operate the engine.

⚠ WARNING

Improperly maintaining this engine, or failure to correct a problem before operation, can cause a malfunction in which you can be seriously hurt or killed.

Always perform a pre-operation inspection before each operation, and correct any problem.

Before beginning your pre-operation checks, be sure the engine is level and the engine switch is in the OFF position.

Always check the following items before you start the engine:

Check the General Condition of the Engine

1. Look around and underneath the engine for signs of oil or gasoline leaks.
2. Remove any excessive dirt or debris, especially around the muffler and recoil starter.
3. Look for signs of damage.
4. Check that all shields and covers are in place, and all nuts, bolts, and screws are tightened.

Check the Engine

1. Check the fuel level (see page 8). Starting with a full tank will help to eliminate or reduce operating interruptions for refueling.
2. Check the engine oil level (see page 9). Running the engine with a low oil level can cause engine damage.

The Oil Alert system (applicable types) will automatically stop the engine before the oil level falls below safe limits. However, to avoid the inconvenience of an unexpected shutdown, always check the engine oil level before startup.

3. Check the reduction case oil level on applicable types (see page 9). Oil is essential to reduction case operation and long life.
4. Check the air filter element (see page 10). A dirty air filter element will restrict air flow to the carburetor, reducing engine performance.
5. Check the equipment powered by this engine.

Review the instructions provided with the equipment powered by this engine for any precautions and procedures that should be followed before engine startup.

OPERATION

SAFE OPERATING PRECAUTIONS

Before operating the engine for the first time, please review the **SAFETY INFORMATION** section on page 2 and the **BEFORE OPERATION CHECKS** on page 3.

⚠ WARNING

Carbon monoxide gas is toxic. Breathing it can cause unconsciousness and even kill you.

Avoid any areas or actions that expose you to carbon monoxide.

Review the instructions provided with the equipment powered by this engine for any safety precautions that should be observed with engine startup, shutdown or operation.

STARTING THE ENGINE

1. Move the fuel valve lever to the ON position.

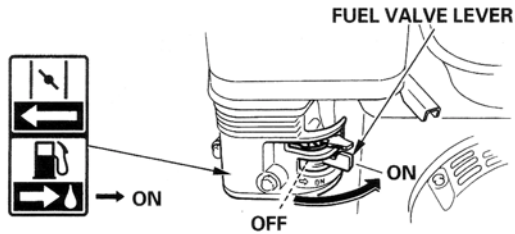

2. To start a cold engine, move the choke lever to the CLOSED position.

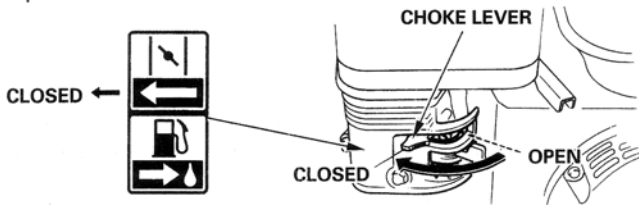

To restart a warm engine, leave the choke lever in the OPEN position.

Some engine applications use a remote-mounted choke control rather than the engine-mounted choke lever shown here. Refer to the instructions provided by the equipment manufacturer.

3. Move the throttle lever away from the MIN. position, about 1/3 of the way toward the MAX. position.

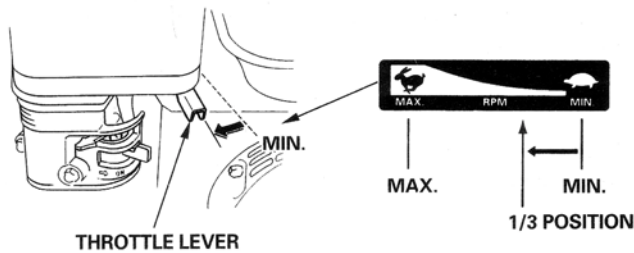

Some engine applications use a remote-mounted throttle control rather than the engine-mounted throttle lever shown here. Refer to the instructions provided by the equipment manufacturer.

4. Turn the engine switch to the ON position.

EXCEPT ELECTRIC STARTER TYPES

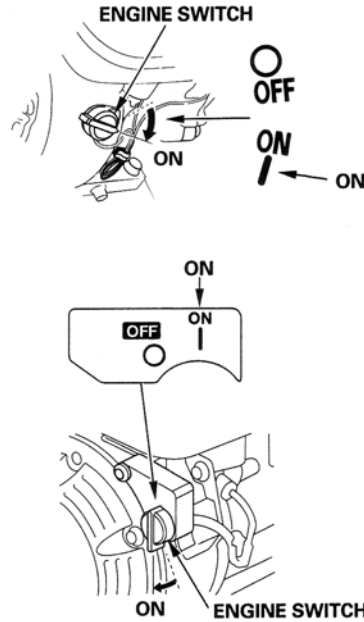

ELECTRIC STARTER TYPES

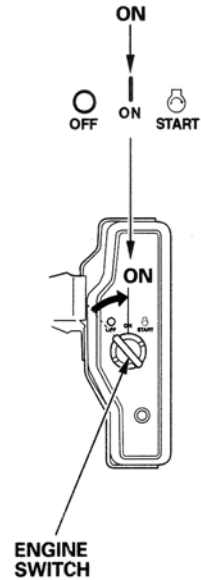

5. Operate the starter.

RECOIL STARTER:

Pull the starter grip lightly until you feel resistance, then pull briskly in the direction of the arrow as shown below. Return the starter grip gently.

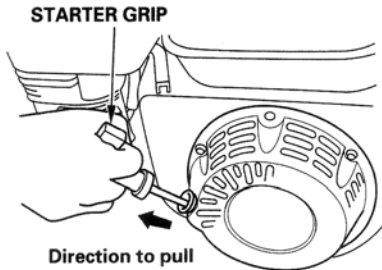

NOTICE

Do not allow the starter grip to snap back against the engine. Return it gently to prevent damage to the starter.

ELECTRIC STARTER (applicable types):

Turn the key to the START position, and hold it there until the engine starts.

If the engine fails to start within 5 seconds, release the key, and wait at least 10 seconds before operating the starter again.

NOTICE

Using the electric starter for more than 5 seconds at a time will overheat the starter motor and can damage it.

When the engine starts, release the key, allowing it to return to the ON position.

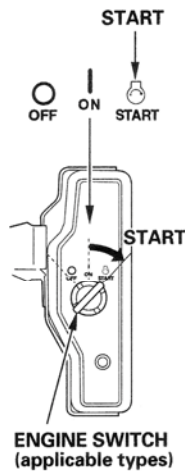

6. If the choke lever was moved to the CLOSED position to start the engine, gradually move it to the OPEN position as the engine warms up.

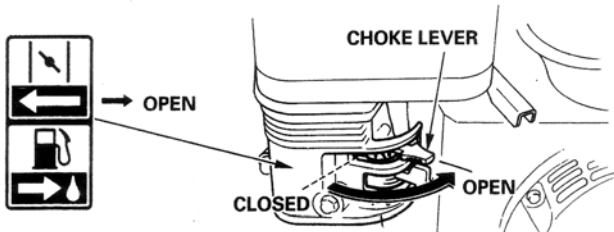

STOPPING THE ENGINE

To stop the engine in an emergency, simply turn the engine switch to the OFF position. Under normal conditions, use the following procedure. Refer to the instructions provided by the equipment manufacturer.

1. Move the throttle lever to the MIN. position.

Some engine applications use a remote-mounted throttle control rather than the engine-mounted throttle lever shown here.



2. Turn the engine switch to the OFF position.

EXCEPT ELECTRIC STARTER TYPES

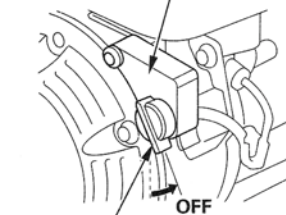
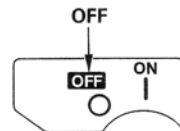
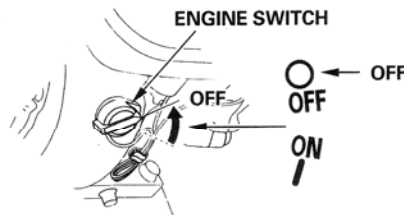

ENGINE SWITCH

ELECTRIC STARTER TYPES

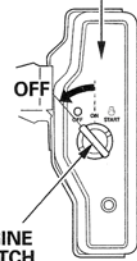
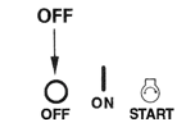

ENGINE SWITCH

3. Turn the fuel valve lever to the OFF position.

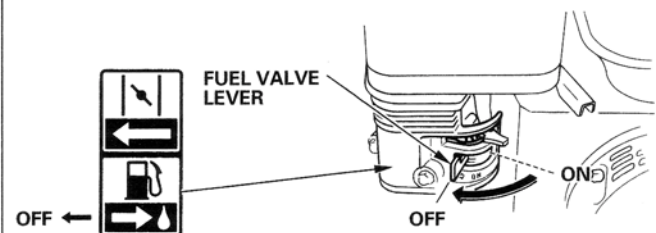

SETTING ENGINE SPEED

Position the throttle lever for the desired engine speed.

Some engine applications use a remote-mounted throttle control rather than the engine-mounted throttle lever shown here. Refer to the instructions provided by the equipment manufacturer.

For engine speed recommendations, refer to the instructions provided with the equipment powered by this engine.

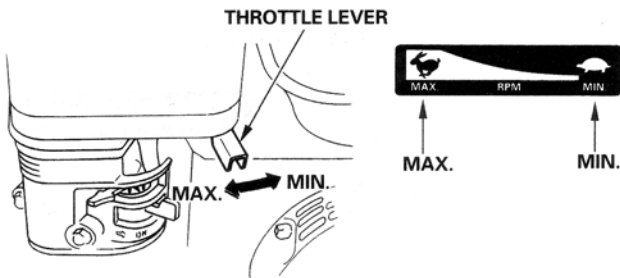

SERVICING YOUR ENGINE

THE IMPORTANCE OF MAINTENANCE

Good maintenance is essential for safe, economical and trouble-free operation. It will also help reduce pollution.

⚠ WARNING

Improper maintenance, or failure to correct a problem before operation, can cause a malfunction in which you can be seriously hurt or killed.

Always follow the inspection and maintenance recommendations and schedules in this owner's manual.

To help you properly care for your engine, the following pages include a maintenance schedule, routine inspection procedures, and simple maintenance procedures using basic hand tools. Other service tasks that are more difficult, or require special tools, are best handled by professionals and are normally performed by a Honda technician or other qualified mechanic.

The maintenance schedule applies to normal operating conditions. If you operate your engine under severe conditions, such as sustained high-load or high-temperature operation, or use in unusually wet or dusty conditions, consult your servicing dealer for recommendations applicable to your individual needs and use.

Maintenance, replacement, or repair of the emission control devices and systems may be performed by any engine repair establishment or individual, using parts that are "certified" to EPA standards.

MAINTENANCE SAFETY

Some of the most important safety precautions follow. However, we cannot warn you of every conceivable hazard that can arise in performing maintenance. Only you can decide whether or not you should perform a given task.

⚠ WARNING

Failure to properly follow maintenance instructions and precautions can cause you to be seriously hurt or killed.

Always follow the procedures and precautions in this owner's manual.

SAFETY PRECAUTIONS

- Make sure the engine is off before you begin any maintenance or repairs. This will eliminate several potential hazards:
 - **Carbon monoxide poisoning from engine exhaust.**
Be sure there is adequate ventilation whenever you operate the engine.
 - **Burns from hot parts.**
Let the engine and exhaust system cool before touching.
 - **Injury from moving parts.**
Do not run the engine unless instructed to do so.
- Read the instructions before you begin, and make sure you have the tools and skills required.
- To reduce the possibility of fire or explosion, be careful when working around gasoline. Use only a non-flammable solvent, not gasoline, to clean parts. Keep cigarettes, sparks and flames away from all fuel related parts.

Remember that an authorized Honda servicing dealer knows your engine best and is fully equipped to maintain and repair it. To ensure the best quality and reliability, use only new genuine Honda parts or their equivalents for repair and replacement.

MAINTENANCE SCHEDULE

REGULAR SERVICE PERIOD (3) Perform at every indicated month or operating hour interval, whichever comes first.		Each Use	First Month or 20 Hrs	Every 3 Months or 50 Hrs	Every 6 Months or 100 Hrs	Every Year or 300 Hrs	Refer to Page
ITEM							
Engine oil	Check level	○					9
	Change		○		○		9
Reduction case oil (applicable types)	Check level	○					9 – 10
	Change		○		○		10
Air filter	Check	○					10
	Clean			○ (1)	○ * (1)		11 – 12
	Replace					○ * * *	
Sediment cup	Clean				○		12
Spark plug	Check-adjust				○		12
	Replace					○	
Spark arrester (applicable types)	Clean				○		13
Idle speed	Check-adjust					○ (2)	13
Valve clearance	Check-adjust					○ (2)	Shop manual
Combustion chamber	Clean		After every 500 Hrs. (2)				Shop manual
Fuel tank & filter	Clean				○ (2)		Shop manual
Fuel tube	Check		Every 2 years (Replace if necessary) (2)				Shop manual

- * • Internal vent carburetor with dual element type only.
- Cyclone type every 6 months or 150 hours.

INTERNAL VENT CARBURETOR TYPE

BREATHER TUBE

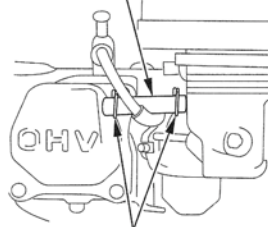

TUBE CLIP

STANDARD TYPE

BREATHER TUBE

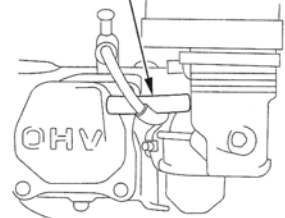

- * * • Replace paper element type only.
- Cyclone type every 2 years or 600 hours.

- (1) Service more frequently when used in dusty areas.
- (2) These items should be serviced by your Honda servicing dealer, unless you have the proper tools and are mechanically proficient. Refer to the Honda shop manual for service procedures.
- (3) For commercial use, log hours of operation to determine proper maintenance intervals.

Failure to follow this maintenance schedule could result in non-warrantable failures.

REFUELING

Recommended Fuel

Unleaded gasoline	
U.S.	Pump octane rating 86 or higher
Except U.S.	Research octane rating 91 or higher
	Pump octane rating 86 or higher

This engine is certified to operate on unleaded gasoline with a pump octane rating of 86 or higher (a research octane rating of 91 or higher).

Refuel in a well-ventilated area with the engine stopped. If the engine has been running, allow it to cool first. Never refuel the engine inside a building where gasoline fumes may reach flames or sparks.

You may use regular unleaded gasoline containing no more than 10% Ethanol (E10) or 5% Methanol by volume. In addition, Methanol must contain cosolvents and corrosion inhibitors. Use of fuels with content of Ethanol or Methanol greater than shown above may cause starting and/or performance problems. It may also damage metal, rubber, and plastic parts of the fuel system. Engine damage or performance problems that result from using a fuel with percentages of Ethanol or Methanol greater than shown above are not covered under warranty.

⚠ WARNING

Gasoline is highly flammable and explosive, and you can be burned or seriously injured when refueling.

- Stop engine and keep heat, sparks, and flame away.
- Refuel only outdoors.
- Wipe up spills immediately.

NOTICE

Fuel can damage paint and some types of plastic. Be careful not to spill fuel when filling your fuel tank. Damage caused by spilled fuel is not covered under the Distributor's Limited Warranty.

1. With the engine stopped and on a level surface, remove the fuel filler cap and check the fuel level. Refill the tank if the fuel level is low.
2. Add fuel to the bottom of the fuel level limit of the fuel tank. Do not overfill. Wipe up spilled fuel before starting the engine.

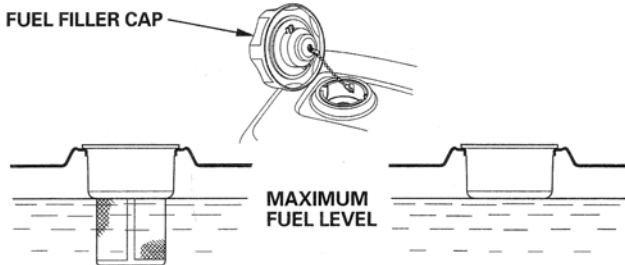

Refuel carefully to avoid spilling fuel. Do not fill the fuel tank completely. It may be necessary to lower the fuel level depending on operating conditions. After refueling, screw the fuel filler cap back on until it clicks.

Keep gasoline away from appliance pilot lights, barbecues, electric appliances, power tools, etc.

Spilled fuel is not only a fire hazard, it causes environmental damage. Wipe up spills immediately.

ENGINE OIL

Oil is a major factor affecting performance and service life. Use 4-stroke automotive detergent oil.

Recommended Oil

Use 4-stroke motor oil that meets or exceeds the requirements for API service classification SJ or later (or equivalent). Always check the API service label on the oil container to be sure it includes the letters SJ or later (or equivalent).

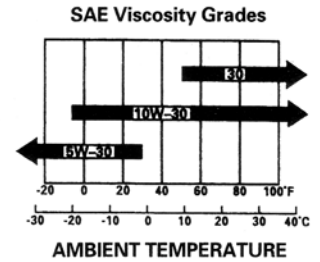

SAE 10W-30 is recommended for general use. Other viscosities shown in the chart may be used when the average temperature in your area is within the indicated range.

Oil Level Check

Check the engine oil level with the engine stopped and in a level position.

1. Remove the oil filler cap/dipstick and wipe it clean.
2. Insert the oil filler cap/dipstick into the oil filler neck as shown, but do not screw it in, then remove it to check the oil level.
3. If the oil level is near or below the lower limit mark on the dipstick, fill with the recommended oil (see page 8) to the upper limit mark (bottom edge of the oil fill hole). Do not overfill.
4. Reinstall the oil filler cap/dipstick.

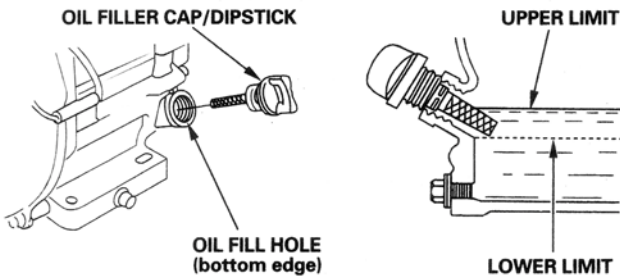

NOTICE

Running the engine with a low oil level can cause engine damage. This type of damage is not covered by the Distributor's Limited Warranty.

The Oil Alert system (applicable types) will automatically stop the engine before the oil level falls below the safe limit. However, to avoid the inconvenience of an unexpected shutdown, always check the engine oil level before startup.

Oil Change

Drain the used oil when the engine is warm. Warm oil drains quickly and completely.

1. Place a suitable container below the engine to catch the used oil, then remove the oil filler cap/dipstick, oil drain plug and washer.
2. Allow the used oil to drain completely, then reinstall the oil drain plug and new washer, and tighten the oil drain plug securely.

Please dispose of used motor oil in a manner that is compatible with the environment. We suggest you take used oil in a sealed container to your local recycling center or service station for reclamation. Do not throw it in the trash, pour it on the ground, or pour it down a drain.

3. With the engine in a level position, fill with the recommended oil to the upper limit mark (bottom edge of the oil fill hole) on the dipstick (see page 8).

NOTICE

Running the engine with a low oil level can cause engine damage. This type of damage is not covered by the Distributor's Limited Warranty.

The Oil Alert system (applicable types) will automatically stop the engine before the oil level falls below the safe limit. However, to avoid the inconvenience of an unexpected shutdown, fill to the upper limit, and check the oil level regularly.

4. Install the oil filler cap/dipstick and tighten securely.

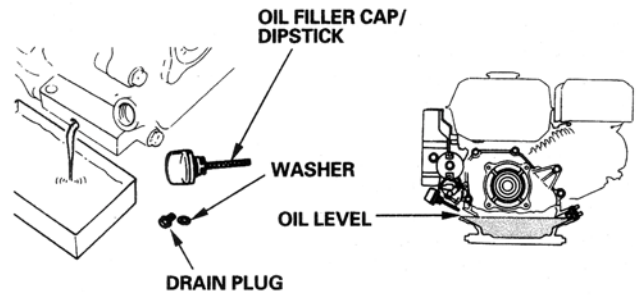

REDUCTION CASE OIL (applicable types)

Recommended Oil

Use the same oil that is recommended for the engine (see page 8).

Oil Level Check

Check the reduction case oil level with the engine stopped and in a level position.

2 : 1 Reduction Case With Centrifugal Clutch

1. Remove the oil filler cap/dipstick and wipe it clean.
2. Insert and remove the oil filler cap/dipstick without screwing it into the filler hole. Check the oil level shown on the oil filler cap/dipstick.
3. If the oil level is low, add the recommended oil to reach the upper limit mark on the dipstick.
4. Screw in the oil filler cap/dipstick and tighten securely.

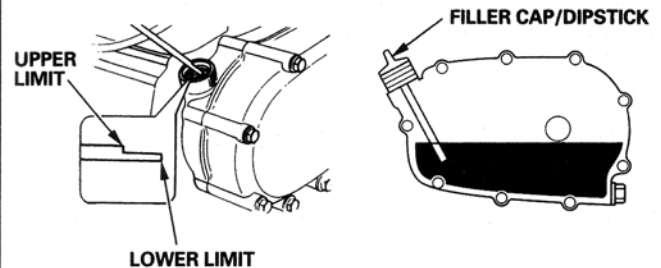

6 : 1 Reduction Case

1. Remove the oil-level-check bolt and washer, and see whether the oil level is at the edge of the bolt hole.
2. If the oil level is below the check bolt hole, remove the filler bolt and washer. Add oil until it starts to flow out the check bolt hole with the recommended oil (see page 9).
3. Install the oil-level-check bolt, filler bolt and washers. Tighten them securely.

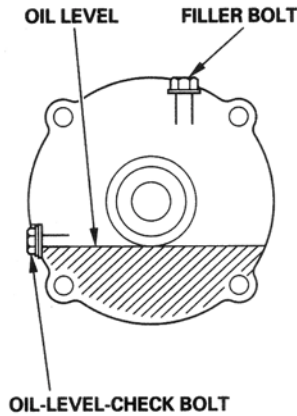

Oil Change

2 : 1 Reduction Case With Centrifugal Clutch

Drain the used oil while the engine is warm. Warm oil drains quickly and completely.

1. Place a suitable container below the reduction case to catch the used oil, then remove the oil filler cap/dipstick, the drain plug and washer.
2. Allow the used oil to drain completely, then reinstall the drain plug and a new washer, and tighten it securely.

Please dispose of used motor oil in a manner that is compatible with the environment. We suggest you take used oil in a sealed container to your local recycling center or service station for reclamation. Do not throw it in the trash or pour it on the ground or pour it down a drain.

3. With the engine in a level position, fill with the recommended oil to the upper limit mark on the dipstick (see page 9). To check the oil level, insert and remove the dipstick without screwing it into the filler hole.

Reduction case oil capacity: 0.50 l (0.53 US qt , 0.44 Imp qt)

NOTICE

Running the engine with a low reduction case oil level can cause reduction case damage.

4. Screw in the filler cap/dipstick securely.

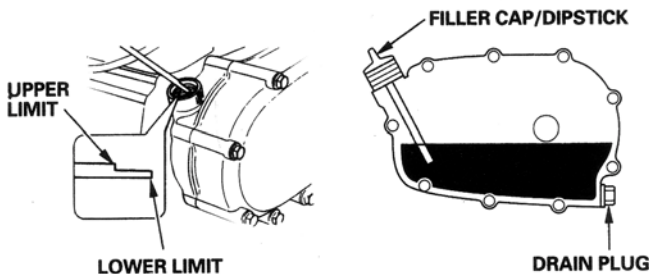

6 : 1 Reduction Case

Drain the used oil while the engine is warm. Warm oil drains quickly and completely.

1. Place a suitable container below the reduction case to catch the used oil, then remove the filler bolt, oil-level-check bolt and washers.
2. Drain the used oil completely into the container by tipping the engine toward the oil-level-check bolt hole.

Please dispose of used motor oil in a manner that is compatible with the environment. We suggest you take used oil in a sealed container to your local recycling center or service station for reclamation. Do not throw it in the trash or pour it on the ground or pour it down a drain.

3. With the engine in a level position, fill with the recommended oil until it starts to flow out the check bolt hole (see page 9).

NOTICE

Running the engine with a low reduction case oil level can cause reduction case damage.

4. Reinstall the oil-level-check bolt, filler bolt and new washers, and tighten them securely.

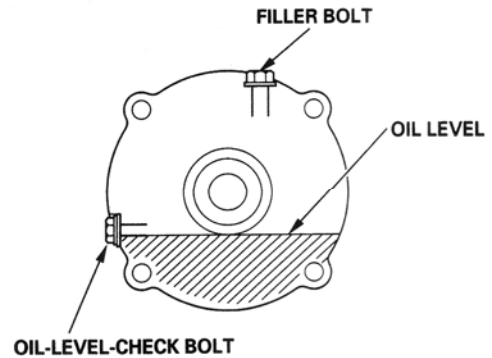

AIR CLEANER

A dirty air cleaner will restrict air flow to the carburetor, reducing engine performance. If you operate the engine in very dusty areas, clean the air filter more often than specified in the MAINTENANCE SCHEDULE.

NOTICE

Operating the engine without an air filter, or with a damaged air filter, will allow dirt to enter the engine, causing rapid engine wear. This type of damage is not covered by the Distributor's Limited Warranty.

Inspection

Remove the air cleaner cover and inspect the filter elements. Clean or replace dirty filter elements. Always replace damaged filter elements. If equipped with an oil-bath air cleaner, also check the oil level.

Refer to pages 11 – 12 for instructions that apply to the air cleaner and filter for your engine type.

Cleaning

Dual-Filter Element Types

1. Remove the wing nut from the air cleaner cover, and remove the cover.
2. Remove the wing nut from the air filter, and remove the filter.
3. Remove the foam filter from the paper filter.
4. Inspect both air filter elements, and replace them if they are damaged. Always replace the paper air filter element at the scheduled interval (see page 7).

STANDARD DUAL-FILTER-ELEMENT TYPE

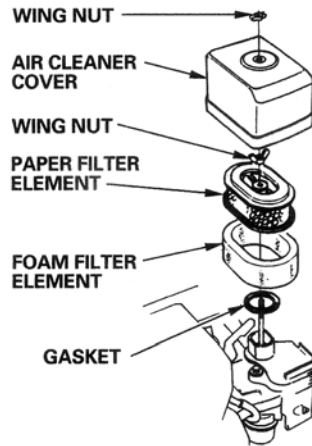

CYCLONE DUAL-FILTER ELEMENT TYPE

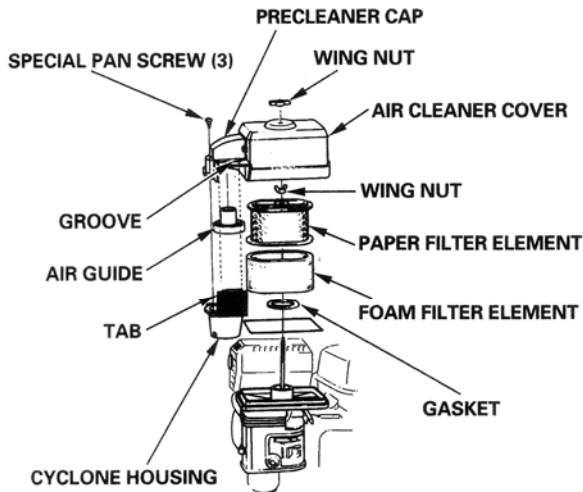

5. Clean the air filter elements if they are to be reused.

Paper air filter element: Tap the filter element several times on a hard surface to remove dirt, or blow compressed air [not exceeding 207 kPa (2.1 kgf/cm², 30 psi)] through the filter element from the inside. Never try to brush off dirt; brushing will force dirt into the fibers.

Foam air filter element: Clean in warm soapy water, rinse, and allow to dry thoroughly. Or clean in non-flammable solvent and allow to dry. Dip the filter element in clean engine oil, then squeeze out all excess oil. The engine will smoke when started if too much oil is left in the foam.

6. CYCLONE TYPE ONLY: Remove the three pan-head screws from the pre-cleaner cap, then remove the cyclone housing and air guide. Wash the parts with water, dry them thoroughly, and reassemble them.

Be sure to install the air guide as shown in the illustration.

Install the cyclone housing so the air intake tab fits into the groove in the pre-cleaner cap.

7. Wipe dirt from the inside of the air cleaner case and cover using a moist rag. Be careful to prevent dirt from entering the air duct that leads to the carburetor.

8. Place the foam air filter element over the paper element, and reinstall the assembled air filter. Be sure the gasket is in place beneath the air filter. Tighten the air filter wing nut securely.

9. Install the air cleaner cover, and tighten the wing nut securely.

Oil-Bath Type

1. Remove the wing nut, and remove the air cleaner cap and cover.
2. Remove the air filter element from the cover. Wash the cover and filter element in warm soapy water, rinse, and allow to dry thoroughly. Or clean in non-flammable solvent and allow to dry.
3. Dip the filter element in clean engine oil, then squeeze out all excess oil. The engine will smoke if too much oil is left in the foam.
4. Empty the used oil from the air cleaner case, wash out any accumulated dirt with non-flammable solvent, and dry the case.
5. Fill the air cleaner case to the OIL LEVEL mark with the same oil that is recommended for the engine (see page 8).

Oil capacity: 60 cm³ (2.0 US oz ; 2.1 Imp oz)

6. Reassemble the air cleaner, and tighten the wing nut securely.

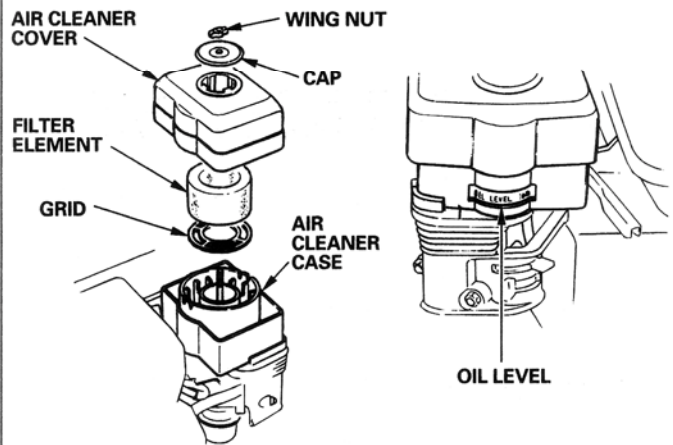

Low Profile Types

1. Unsnap the air cleaner cover clips, remove the air cleaner cover, and remove the air filter element.
2. Wash the element in a solution of household detergent and warm water, then rinse thoroughly, or wash in non-flammable or high flash point solvent. Allow the element to dry thoroughly.
3. Soak the air filter element in clean engine oil and squeeze out the excess oil. The engine will smoke during initial startup if too much oil is left in the element.
4. Reinstall the air filter element and the cover.

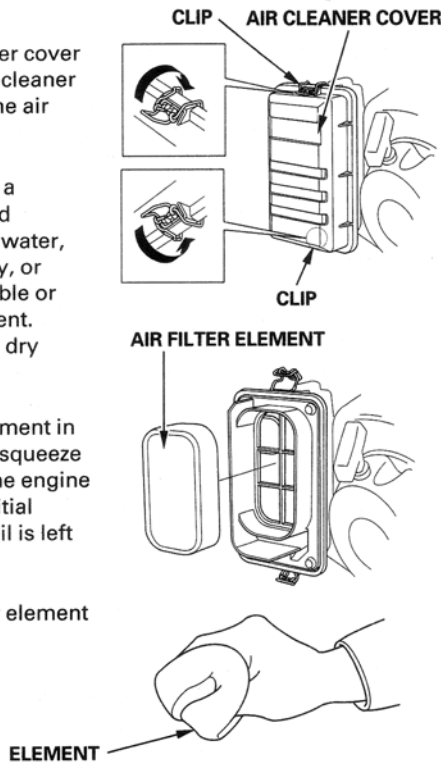

SEDIMENT CUP

Cleaning

⚠ WARNING

Gasoline is highly flammable and explosive, and you can be burned or seriously injured when handling fuel.

- Stop engine and keep heat, sparks, and flame away.
- Handle fuel only outdoors.
- Wipe up spills immediately.

1. Move the fuel valve to the OFF position, then remove the fuel sediment cup and O-ring.
2. Wash the sediment cup and O-ring in nonflammable solvent, and dry them thoroughly.

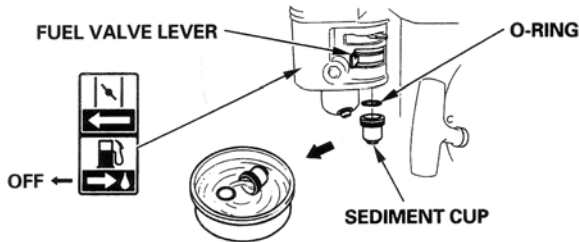

3. Place the O-ring in the fuel valve, and install the sediment cup. Tighten the sediment cup securely.

4. Move the fuel valve to the ON position, and check for leaks. Replace the O-ring if there is any leakage.

SPARK PLUG

Recommended Spark Plugs: BPR6ES (NGK)
W20EPR-U (DENSO)

The recommended spark plug has the correct heat range for normal engine operating temperatures.

NOTICE

An incorrect spark plug can cause engine damage.

For good performance, the spark plug must be properly gapped and free of deposits.

1. Disconnect the spark plug cap, and remove any dirt from around the spark plug area.
2. Remove the spark plug with a 13/16-inch spark plug wrench.
3. Inspect the spark plug. Replace it if damaged or badly fouled, if the sealing washer is in poor condition, or if the electrode is worn.

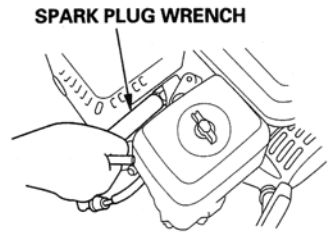

4. Measure the spark plug electrode gap with a wire-type feeler gauge. Correct the gap, if necessary, by carefully bending the side electrode. The gap should be: 0.70–0.80 mm (0.028–0.031 in)

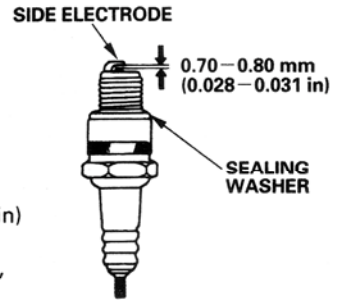

5. Install the spark plug carefully, by hand, to avoid cross-threading.
6. After the spark plug is seated, tighten with a 13/16-inch spark plug wrench to compress the sealing washer.
7. When installing a new spark plug, tighten 1/2 turn after the spark plug seats to compress the washer.
8. When reinstalling the original spark plug, tighten 1/8–1/4 turn after the spark plug seats to compress the washer.

NOTICE

A loose spark plug can overheat and damage the engine. Overtightening the spark plug can damage the threads in the cylinder head.

9. Attach the spark plug cap to the spark plug.

SPARK ARRESTER (applicable types)

The spark arrester may be standard or an optional part, depending on the engine type. In some areas, it is illegal to operate an engine without a spark arrester. Check local laws and regulations. A spark arrester is available from authorized Honda servicing dealers.

The spark arrester must be serviced every 100 hours to keep it functioning as designed.

If the engine has been running, the muffler will be hot. Allow it to cool before servicing the spark arrester.

Spark Arrester Removal

1. Remove the two 4 mm screws from the exhaust deflector, and remove the deflector (applicable types).
2. Remove the four 5 mm screws from the muffler protector and remove the muffler protector.
3. Remove the 4 mm screw from the spark arrester, and remove the spark arrester from the muffler.

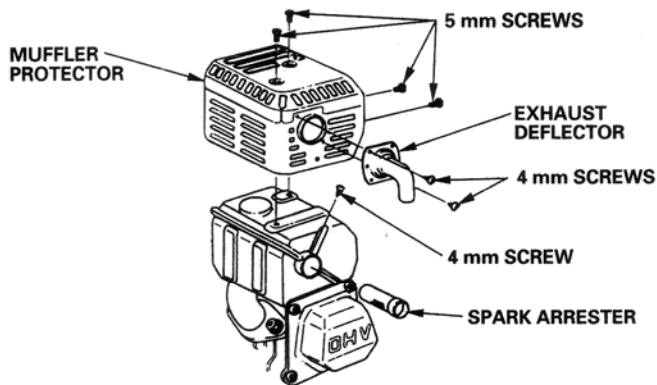

Spark Arrester Cleaning & Inspection

1. Use a brush to remove carbon deposits from the spark arrester screen. Be careful not to damage the screen. Replace the spark arrester if it has breaks or holes.

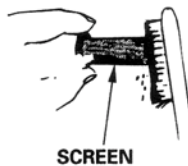

2. Install the spark arrester, muffler protector, and exhaust deflector in the reverse order of removal.

IDLE SPEED

Adjustment

1. Start the engine outdoors, and allow it to warm up to operating temperature.
2. Move the throttle lever to its minimum position.
3. Turn the throttle stop screw to obtain the standard idle speed.

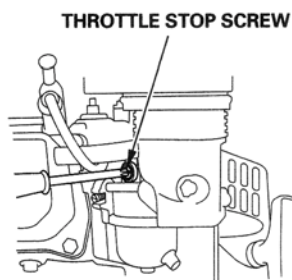

Standard idle speed: 1,400 \pm 200 / -150 rpm

HELPFUL TIPS & SUGGESTIONS

STORING YOUR ENGINE

Storage Preparation

Proper storage preparation is essential for keeping your engine trouble-free and looking good. The following steps will help to keep rust and corrosion from impairing your engine's function and appearance, and will make the engine easier to start when you use it again.

Cleaning

If the engine has been running, allow it to cool for at least half an hour before cleaning. Clean all exterior surfaces, touch up any damaged paint, and coat other areas that may rust with a light film of oil.

NOTICE

Using a garden hose or pressure washing equipment can force water into the air cleaner or muffler opening. Water in the air cleaner will soak the air filter, and water that passes through the air filter or muffler can enter the cylinder, causing damage.

Fuel

Gasoline will oxidize and deteriorate in storage. Deteriorated gasoline will cause hard starting, and it leaves gum deposits that clog the fuel system. If the gasoline in your engine deteriorates during storage, you may need to have the carburetor and other fuel system components serviced or replaced.

The length of time that gasoline can be left in your fuel tank and carburetor without causing functional problems will vary with such factors as gasoline blend, your storage temperatures, and whether the fuel tank is partially or completely filled. The air in a partially filled fuel tank promotes fuel deterioration. Very warm storage temperatures accelerate fuel deterioration. Fuel problems may occur within a few months, or even less if the gasoline was not fresh when you filled the fuel tank.

Fuel system damage or engine performance problems resulting from neglected storage preparation are not covered under the *Distributor's Limited Warranty*.

You can extend fuel storage life by adding a gasoline stabilizer that is formulated for that purpose, or you can avoid fuel deterioration problems by draining the fuel tank and carburetor.

Adding a Gasoline Stabilizer to Extend Fuel Storage Life

When adding a gasoline stabilizer, fill the fuel tank with fresh gasoline. If only partially filled, air in the tank will promote fuel deterioration during storage. If you keep a container of gasoline for refueling, be sure that it contains only fresh gasoline.

1. Add gasoline stabilizer following the manufacturer's instructions.
2. After adding a gasoline stabilizer, run the engine outdoors for 10 minutes to be sure that treated gasoline has replaced the untreated gasoline in the carburetor.
3. Stop the engine.

Draining the Fuel Tank and Carburetor

⚠ WARNING

Gasoline is highly flammable and explosive, and you can be burned or seriously injured when handling fuel.

- Stop engine and keep heat, sparks, and flame away.
- Handle fuel only outdoors.
- Wipe up spills immediately.

1. Place an approved gasoline container below the carburetor, and use a funnel to avoid spilling fuel.
2. Remove the carburetor drain bolt and gasket. Remove the sediment cup and O-ring, then move the fuel valve lever to the ON position.

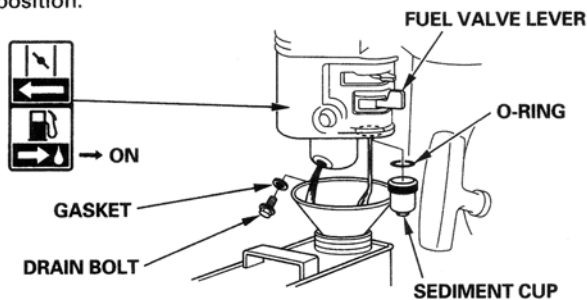

3. After all the fuel has drained into the container, reinstall the drain bolt, gasket, sediment cup and O-ring. Tighten the drain bolt and sediment cup securely.

Engine Oil

1. Change the engine oil (see page 9).
2. Remove the spark plug (see page 12).
3. Pour a tablespoon 5 – 10 cm³ (5 – 10 cc) of clean engine oil into the cylinder.
4. Pull the starter rope several times to distribute the oil in the cylinder.
5. Reinstall the spark plug.
6. Pull the starter rope slowly until resistance is felt and the notch on the starter pulley aligns with the hole at the top of the recoil starter cover. This will close the valves so moisture cannot enter the engine cylinder. Return the starter rope gently.

Align notch on pulley with hole at top of cover.

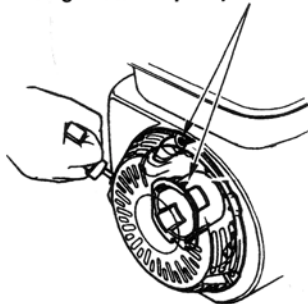

Storage Precautions

If your engine will be stored with gasoline in the fuel tank and carburetor, it is important to reduce the hazard of gasoline vapor ignition. Select a well-ventilated storage area away from any appliance that operates with a flame, such as a furnace, water heater, or clothes dryer. Also avoid any area with a spark-producing electric motor, or where power tools are operated.

If possible, avoid storage areas with high humidity, because that promotes rust and corrosion.

Keep the engine level in storage. Tilting can cause fuel or oil leakage.

With the engine and exhaust system cool, cover the engine to keep out dust. A hot engine and exhaust system can ignite or melt some materials. Do not use sheet plastic as a dust cover. A nonporous cover will trap moisture around the engine, promoting rust and corrosion.

If equipped with a battery for electric starter types, recharge the battery once a month while the engine is in storage. This will help to extend the service life of the battery.

Removal from Storage

Check your engine as described in the *BEFORE OPERATION CHECKS* section of this manual (see page 3).

If the fuel was drained during storage preparation, fill the tank with fresh gasoline. If you keep a container of gasoline for refueling, be sure it contains only fresh gasoline. Gasoline oxidizes and deteriorates over time, causing hard starting.

If the cylinder was coated with oil during storage preparation, the engine will smoke briefly at startup. This is normal.

TRANSPORTING

Keep the engine level when transporting to reduce the possibility of fuel leakage. Turn the fuel valve to the OFF position (see page 5).

TAKING CARE OF UNEXPECTED PROBLEMS

ENGINE WILL NOT START	Possible Cause	Correction
1. Electric starting (applicable types): Check battery and fuse.	Battery discharged.	Recharge battery.
	Fuse burnt out.	Replace fuse (p. 15).
2. Check control positions.	Fuel valve OFF.	Move lever to ON position.
	Choke open.	Move lever to CLOSED position unless the engine is warm.
	Engine switch OFF.	Turn engine switch to ON position.
3. Check engine oil level.	Engine oil level low (Oil Alert models).	Fill with the recommended oil to the proper level (p. 9).
4. Check fuel.	Out of fuel.	Refuel (p. 8).
	Bad fuel; engine stored without treating or draining gasoline, or refueled with bad gasoline.	Drain fuel tank and carburetor (p. 14). Refuel with fresh gasoline (p. 8).
5. Remove and inspect spark plug.	Spark plug faulty, fouled, or improperly gapped.	Gap or replace spark plug (p. 12).
	Spark plug wet with fuel (flooded engine).	Dry and reinstall spark plug. Start engine with throttle lever in MAX. position.
6. Take engine to an authorized Honda servicing dealer, or refer to shop manual.	Fuel filter restricted, carburetor malfunction, ignition malfunction, valves stuck, etc.	Replace or repair faulty components as necessary.

ENGINE LACKS POWER	Possible Cause	Correction
1. Check air filter.	Filter element(s) restricted.	Clean or replace filter element(s) (p. 11–12).
2. Check fuel.	Bad fuel; engine stored without treating or draining gasoline, or refueled with bad gasoline.	Drain fuel tank and carburetor (p. 14). Refuel with fresh gasoline (p. 8).
3. Take engine to an authorized Honda servicing dealer, or refer to shop manual.	Fuel filter restricted, carburetor malfunction, ignition malfunction, valves stuck, etc.	Replace or repair faulty components as necessary.

FUSE REPLACEMENT (applicable types)

The electric starter relay circuit and battery charging circuit are protected by a fuse. If the fuse burns out, the electric starter will not operate. The engine can be started manually if the fuse burns out, but running the engine will not charge the battery.

1. Remove the 6 × 12 mm screw from the rear cover of the engine switch box.
2. Remove the fuse cover, then pull out and inspect the fuse.

If the fuse is burnt out, discard the burnt-out fuse. Install a new fuse with the same rating as the one that was removed, and reinstall the cover.

If you have questions regarding the rating of the original fuse, contact your servicing Honda engine dealer.

NOTICE

Never use a fuse with a rating greater than the one originally equipped with the engine. Serious damage to the electrical system or a fire could result.

3. Reinstall the rear cover. Install the 6 × 12 mm screw and tighten it securely.

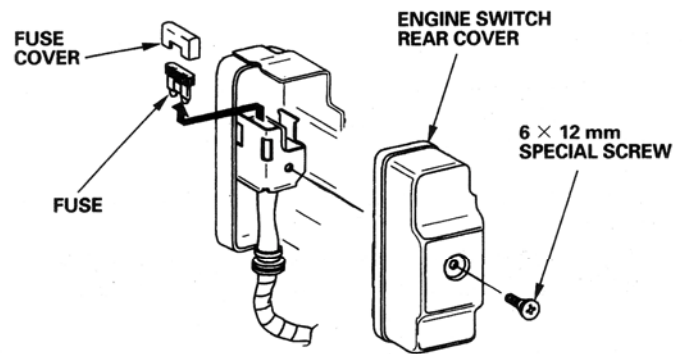

Frequent fuse failure usually indicates a short circuit or an overload in the electrical system. If the fuse burns out frequently, take the engine to a servicing Honda dealer for repair.

TECHNICAL INFORMATION

Serial Number Location

Record the engine serial number, type and purchase date in the space below. You will need this information when ordering parts and when making technical or warranty inquiries.

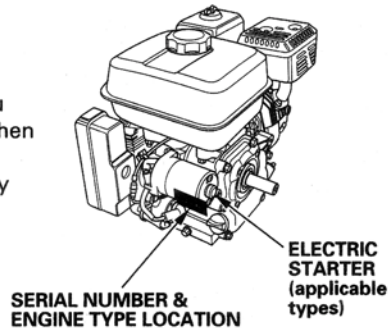

Engine serial number: _____

Engine type: _____

Date Purchased: ____ / ____ / ____

Battery Connections for Electric Starter (applicable types)

Use a 12-volt battery with an ampere-hour rating of at least 18 Ah.

Be careful not to connect the battery in reverse polarity, as this will short circuit the battery charging system. Always connect the positive (+) battery cable to the battery terminal before connecting the negative (-) battery cable, so your tools cannot cause a short circuit if they touch a grounded part while tightening the positive (+) battery cable end.

⚠ WARNING

A battery can explode if you do not follow the correct procedure, seriously injuring anyone nearby.

Keep all sparks, open flames, and smoking materials away from the battery.

1. Connect the battery positive (+) cable to the starter solenoid terminal as shown.
2. Connect the battery negative (-) cable to an engine mounting bolt, frame bolt, or other good engine ground connection.
3. Connect the battery positive (+) cable to the battery positive (+) terminal as shown.
4. Connect the battery negative (-) cable to the battery negative (-) terminal as shown.
5. Coat the terminals and cable ends with grease.

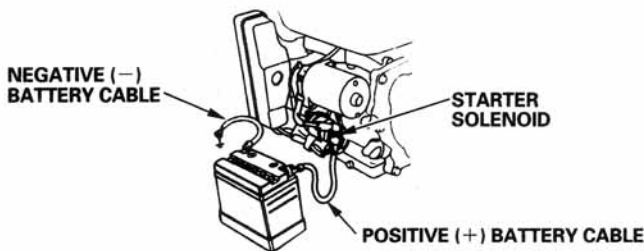

Remote Control Linkage

The throttle and choke control levers are provided with holes for optional cable attachment. The following illustrations show installation examples for a solid wire cable and for a flexible, braided wire cable. If using a flexible, braided wire cable, add a return spring as shown.

It is necessary to loosen the throttle lever friction nut when operating the throttle with a remote-mounted control.

REMOTE THROTTLE LINKAGE

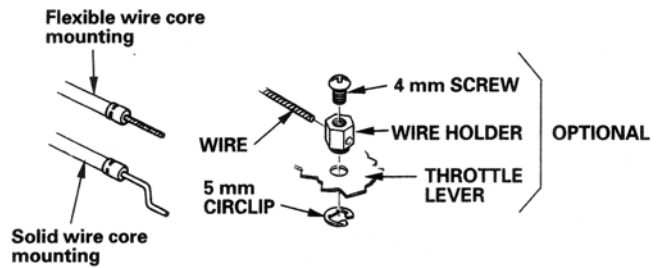
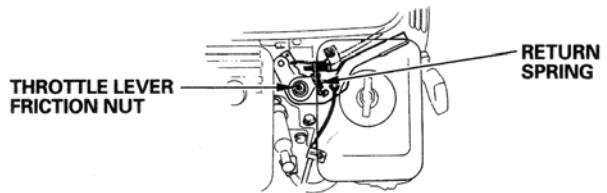

REMOTE CHOKE LINKAGE

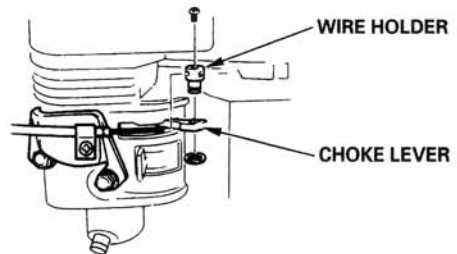



Carburetor Modifications for High Altitude Operation

At high altitude, the standard carburetor air-fuel mixture will be too rich. Performance will decrease, and fuel consumption will increase. A very rich mixture will also foul the spark plug and cause hard starting. Operation at an altitude that differs from that at which this engine was certified, for extended periods of time, may increase emissions.

High altitude performance can be improved by specific modifications to the carburetor. If you always operate your engine at altitudes above 1,500 meters (5,000 feet), have your servicing dealer perform this carburetor modification. This engine, when operated at high altitude with the carburetor modifications for high altitude use, will meet each emission standard throughout its useful life.

Even with carburetor modification, engine horsepower will decrease about 3.5% for each 300-meter (1,000-foot) increase in altitude. The effect of altitude on horsepower will be greater than this if no carburetor modification is made.

NOTICE

When the carburetor has been modified for high altitude operation, the air-fuel mixture will be too lean for low altitude use. Operation at altitudes below 1,500 meters (5,000 feet) with a modified carburetor may cause the engine to overheat and result in serious engine damage. For use at low altitudes, have your servicing dealer return the carburetor to original factory specifications.

Emission Control System Information

Source of Emissions

The combustion process produces carbon monoxide, oxides of nitrogen, and hydrocarbons. Control of hydrocarbons and oxides of nitrogen is very important because, under certain conditions, they react to form photochemical smog when subjected to sunlight. Carbon monoxide does not react in the same way, but it is toxic.

Honda utilizes lean carburetor settings and other systems to reduce the emissions of carbon monoxide, oxides of nitrogen, and hydrocarbons.

The U.S., California Clean Air Acts and Environment Canada
EPA, California and Canadian regulations require all manufacturers to furnish written instructions describing the operation and maintenance of emission control systems.

The following instructions and procedures must be followed in order to keep the emissions from your Honda engine within the emission standards.

Tampering and Altering

Tampering with or altering the emission control system may increase emissions beyond the legal limit. Among those acts that constitute tampering are:

- Removal or alteration of any part of the intake, fuel, or exhaust systems.
- Altering or defeating the governor linkage or speed-adjusting mechanism to cause the engine to operate outside its design parameters.

Problems That May Affect Emissions

If you are aware of any of the following symptoms, have your engine inspected and repaired by your servicing dealer.

- Hard starting or stalling after starting.
- Rough idle.
- Misfiring or backfiring under load.
- Afterburning (backfiring).
- Black exhaust smoke or high fuel consumption.

Replacement Parts

The emission control systems on your Honda engine were designed, built, and certified to conform with EPA, California and Canadian emission regulations. We recommend the use of genuine Honda parts whenever you have maintenance done. These original-design replacement parts are manufactured to the same standards as the original parts, so you can be confident of their performance. The use of replacement parts that are not of the original design and quality may impair the effectiveness of your emission control system.

A manufacturer of an aftermarket part assumes the responsibility that the part will not adversely affect emission performance. The manufacturer or rebuilder of the part must certify that use of the part will not result in a failure of the engine to comply with emission regulations.

Maintenance

Follow the maintenance schedule on page 7. Remember that this schedule is based on the assumption that your machine will be used for its designed purpose. Sustained high-load or high-temperature operation, or use in unusually wet or dusty conditions, will require more frequent service.



GM-70G Instruction Manual

Air Index

An Air Index Information hang tag/label is applied to engines certified to an emission durability time period in accordance with the requirements of the California Air Resources Board.

The bar graph is intended to provide you, our customer, the ability to compare the emissions performance of available engines. The lower the Air Index, the less pollution.

The durability description is intended to provide you with information relating to the engine's emission durability period. The descriptive term indicates the useful life period for the engine's emission control system. See your *Emission Control System Warranty* for additional information.

Descriptive Term	Applicable to Emissions Durability Period
Moderate	50 hours [0–80 cm ³ (0–80 cc) inclusive] 125 hours [greater than 80 cm ³ (80 cc)]
Intermediate	125 hours [0–80 cm ³ (0–80 cc) inclusive] 250 hours [greater than 80 cm ³ (80 cc)]
Extended	300 hours [0–80 cm ³ (0–80 cc) inclusive] 500 hours [greater than 80 cm ³ (80 cc)] 1,000 hours [225 cm ³ (225 cc) and greater]

The Air Index Information hang tag/label must remain on the engine until it is sold. Remove the hang tag before operating the engine.

Specifications

GX120 (PTO shaft type S)

Length × Width × Height	297 × 341 × 329 mm (11.7 × 13.4 × 13.0 in)
Dry weight	13.0 kg (28.7 lbs)
Engine type	4-stroke, overhead valve, single cylinder
Displacement [Bore × Stroke]	119 cm ³ (7.3 cu-in) [60 × 42 mm (2.4 × 1.7 in)]
Max. output	2.9 kW (4.0 PS, 4.0 bhp) at 3,600 rpm
Max. torque	7.4 N·m (0.75 kgf·m, 5.44 lbf·ft) at 2,500 rpm
Engine oil capacity	0.60 ℓ (0.63 US qt, 0.53 Imp qt)
Fuel tank capacity	2.0 ℓ (0.53 US gal, 0.44 Imp gal)
Fuel consumption	313 g/kWh (230 g/PSh, 0.51 lb/hph)
Cooling system	Forced air
Ignition system	Transistorized magneto
PTO shaft rotation	Counterclockwise

GX160 (PTO shaft type S)

Length × Width × Height	304 × 362 × 346 mm (12.0 × 14.3 × 13.6 in)
Dry weight	15.1 kg (33.3 lbs)
Engine type	4-stroke, overhead valve, single cylinder
Displacement [Bore × Stroke]	163 cm ³ (9.9 cu-in) [68 × 45 mm (2.7 × 1.8 in)]
Max. output	4.0 kW (5.5 PS, 5.5 bhp) at 3,600 rpm
Max. torque	10.8 N·m (1.1 kgf·m, 8.0 lbf·ft) at 2,500 rpm
Engine oil capacity	0.60 ℓ (0.63 US qt, 0.53 Imp qt)
Fuel tank capacity	3.1 ℓ (0.82 US gal, 0.68 Imp gal)
Fuel consumption	313 g/kWh (230 g/PSh, 0.51 lb/hph)
Cooling system	Forced air
Ignition system	Transistorized magneto
PTO shaft rotation	Counterclockwise

GX200 (PTO shaft type S)

Length × Width × Height	313 × 376 × 346 mm (12.3 × 14.8 × 13.6 in)
Dry weight	16.1 kg (35.5 lbs)
Engine type	4-stroke, overhead valve, single cylinder
Displacement [Bore × Stroke]	196 cm ³ (12.0 cu-in) [68 × 54 mm (2.7 × 2.1 in)]
Max. output	4.8 kW (6.5 PS, 6.5 bhp) at 3,600 rpm
Max. torque	13.2 N·m (1.35 kgf·m, 9.76 lbf·ft) at 2,500 rpm
Engine oil capacity	0.60 ℓ (0.63 US qt, 0.53 Imp qt)
Fuel tank capacity	3.1 ℓ (0.82 US gal, 0.68 Imp gal)
Fuel consumption	313 g/kWh (230 g/PSh, 0.51 lb/hph)
Cooling system	Forced air
Ignition system	Transistorized magneto
PTO shaft rotation	Counterclockwise

Tuneup Specifications GX120/160/200

ITEM	SPECIFICATION	MAINTENANCE
Spark plug gap	0.70–0.80 mm (0.028–0.031 in)	Refer to page: 12
Idle speed	1,400 ⁺²⁰⁰ ₋₁₅₀ rpm	Refer to page: 13
Valve clearance (cold)	IN: 0.15 ± 0.02 mm EX: 0.20 ± 0.02 mm	See your authorized Honda dealer
Other specifications	No other adjustments needed.	

Quick Reference Information

Fuel	Unleaded gasoline (Refer to page 8)	
	U.S.	Pump octane rating 86 or higher
	Except U.S.	Research octane rating 91 or higher
	U.S.	Pump octane rating 86 or higher
Engine oil	SAE 10W-30, API SJ or later, for general use. Refer to page 8.	
Reduction case oil	Same oil to engine oil, see above (applicable types).	
Spark plug	BPR6ES (NGK) W20EPR-U (DENSO)	
Maintenance	Before each use:	
	<ul style="list-style-type: none"> • Check engine oil level. Refer to page 9. • Check reduction case oil (applicable types). Refer to page 9 – 10. • Check air filter. Refer to page 10. 	
	First 20 hours:	
	<ul style="list-style-type: none"> • Change engine oil. Refer to page 9. • Change reduction case oil (applicable types). Refer to page 10. 	
	Subsequent: Refer to the maintenance schedule on page 7.	

Wiring Diagrams

With Oil Alert® and Electric Starter

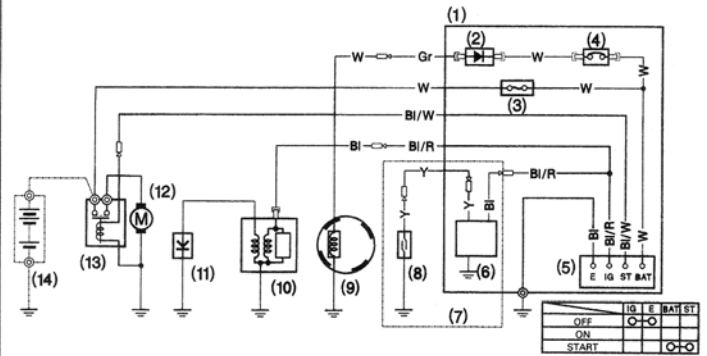

With Oil Alert® and Without Electric Starter

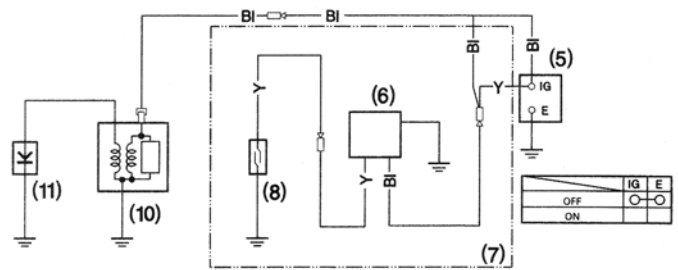

- | | |
|------------------------------|-----------------------|
| (1) CONTROL BOX | (8) OIL LEVEL SWITCH |
| (2) RECTIFIER | (9) CHARGING COIL |
| (3) FUSE | (10) IGNITION COIL |
| (4) CIRCUIT BREAKER | (11) SPARK PLUG |
| (5) ENGINE SWITCH | (12) STARTER MOTOR |
| (6) OIL ALERT UNIT | (13) STARTER SOLENOID |
| (7) Type with Oil Alert unit | (14) BATTERY (12 V) |

Bl	Black	Br	Brown
Y	Yellow	O	Orange
Bu	Blue	Lb	Light blue
G	Green	Lg	Light green
R	Red	P	Pink
W	White	Gr	Gray



GM-70G Instruction Manual

CONSUMER INFORMATION

Distributor/Dealer Locator Information

United States, Puerto Rico, and U.S. Virgin Islands:

Call (800) 426-7701

or visit our website: www.honda-engines.com

Canada:

Call (888) 9HONDA9

or visit our website: www.honda.ca

For European Area:

visit our website: <http://www.honda-engines-eu.com>

Customer Service Information

Servicing dealership personnel are trained professionals. They should be able to answer any question you may have. If you encounter a problem that your dealer does not solve to your satisfaction, please discuss it with the dealership's management. The Service Manager, General Manager, or Owner can help. Almost all problems are solved in this way.

United States, Puerto Rico, and U.S. Virgin Islands:

If you are dissatisfied with the decision made by the dealership's management, contact the Honda Regional Engine Distributor for your area.

If you are still dissatisfied after speaking with the Regional Engine Distributor, you may contact the Honda Office as shown.

All Other Areas:

If you are dissatisfied with the decision made by the dealership's management, contact the Honda Office as shown.

《Honda's Office》

When you write or call, please provide this information:

- Equipment manufacturer's name and model number that the engine is mounted on
- Engine model, serial number, and type (see page 16)
- Name of dealer who sold the engine to you
- Name, address, and contact person of the dealer who services your engine
- Date of purchase
- Your name, address and telephone number
- A detailed description of the problem

United States, Puerto Rico, and U.S. Virgin Islands:

American Honda Motor Co., Inc.

Power Equipment Division

Customer Relations Office

4900 Marconi Drive

Alpharetta, GA 30005-8847

Or telephone: (770) 497-6400, 8:30 am - 8:00 pm EST

Canada:

Honda Canada, Inc.

715 Milner Avenue

Toronto, ON

M1B 2K8

Telephone: (888) 9HONDA9 Toll free

(888) 946-6329

English: (416) 299-3400

French: (416) 287-4776

Facsimile: (877) 939-0909

(416) 287-4776

Local Toronto dialing area

Local Toronto dialing area

Toll free

Local Toronto dialing area

Australia:

Honda Australia Motorcycle and Power Equipment Pty. Ltd.

1954 – 1956 Hume Highway Campbellfield Victoria 3061

Telephone: (03) 9270 1111

Facsimile: (03) 9270 1133

For European Area:

Honda Europe NV.

European Engine Center

<http://www.honda-engines-eu.com>

All Other Areas:

Please contact the Honda distributor in your area for assistance.

HONDA
The Power of Dreams

ENGLISH