

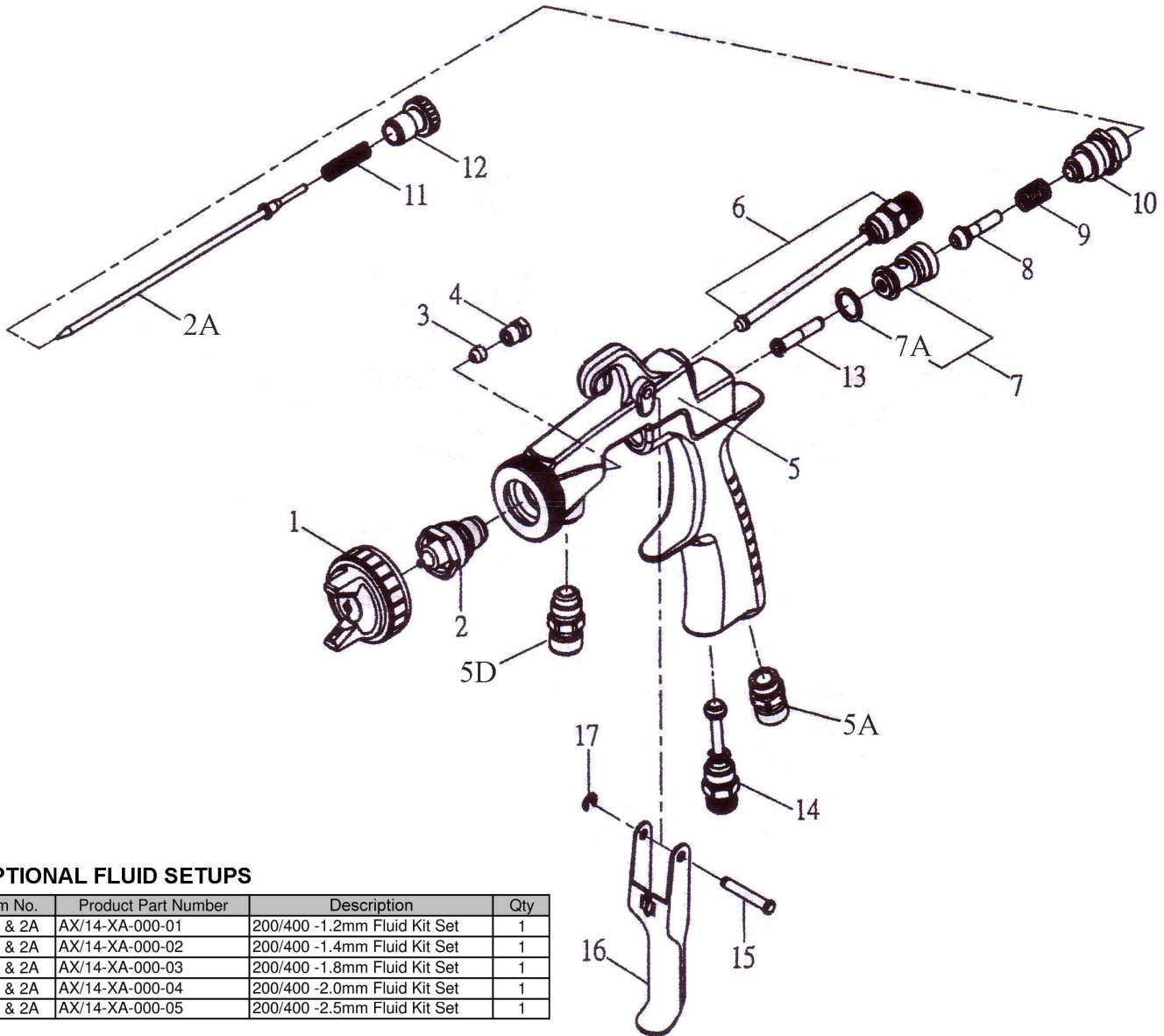

SP200S PARTS BREAKDOWN



OPTIONAL FLUID SETUPS

Item No.	Product Part Number	Description	Qty
1,2 & 2A	AX/14-XA-000-01	200/400 -1.2mm Fluid Kit Set	1
1,2 & 2A	AX/14-XA-000-02	200/400 -1.4mm Fluid Kit Set	1
1,2 & 2A	AX/14-XA-000-03	200/400 -1.8mm Fluid Kit Set	1
1,2 & 2A	AX/14-XA-000-04	200/400 -2.0mm Fluid Kit Set	1
1,2 & 2A	AX/14-XA-000-05	200/400 -2.5mm Fluid Kit Set	1

PARTS LIST

Item No.	Product Part Number	Description	Qty	Item No.	Product Part Number	Description	Qty
1	AX/14-ZA-000-01	200/400 - Air Cap 1.2mm	1	5A	AX/14-ZA-000-18	200/400 - Air Nipple	1
1	AX/14-ZA-000-02	200/400 - Air Cap 1.4mm	1	5B	AX/14-ZA-000-19A	200S - Fluid Nipple	1
1	AX/14-ZA-000-03	200/400 - Air Cap 1.8mm	1	5C	AX/14-ZA-000-19B	400G - Fluid Nipple	1
1	AX/14-ZA-000-04	200/400 - Air Cap 2.0mm	1	5D	AX/14-ZA-000-19C	200G - Fluid Nipple	1
1	AX/14-ZA-000-05	200/400 - Air Cap 2.5mm	1	6	AX/14-ZA-000-20	200/400 - Pattern Adj Set	1
2	AX/14-ZA-000-06	200/400 - Fluid Nozzle 1.2mm	1	7	AX/14-ZA-000-21	200/400 - Air Valve Seat Set	1
2	AX/14-ZA-000-07	200/400 - Fluid Nozzle 1.4mm	1	7A	AX/14-ZA-000-22	200/400 - O-Ring	1
2	AX/14-ZA-000-08	200/400 - Fluid Nozzle 1.8mm	1	8	AX/14-ZA-000-23	200/400 - Air Valve	1
2	AX/14-ZA-000-09	200/400 - Fluid Nozzle 2.0mm	1	9	AX/14-ZA-000-24	200/400 - Air Valve Spring	1
2	AX/14-ZA-000-10	200/400 - Fluid Nozzle 2.5mm	1	10	AX/14-ZA-000-25	200/400 - Fluid Adj Guide	1
2A	AX/14-ZA-000-11	200/400 - Fluid Needle 1.2mm	1	11	AX/14-ZA-000-26	200/400 - Fluid Needle Spring	1
2A	AX/14-ZA-000-12	200/400 - Fluid Needle 1.4mm	1	12	AX/14-ZA-000-27	200/400 - Fluid Adj Knob	1
2A	AX/14-ZA-000-13	200/400 - Fluid Needle 1.8mm	1	13	AX/14-ZA-000-28	200/400 - Air Valve Shaft	1
2A	AX/14-ZA-000-14	200/400 - Fluid Needle 2.0mm	1	14	AX/14-ZA-000-29	200/400 - Air Adj Set	1
2A	AX/14-ZA-000-15	200/400 - Fluid Needle 2.5mm	1	15	AX/14-ZA-000-30	200/400 - Trigger Stud	1
3	AX/14-ZA-000-16	200/400 - Needle Packing Seat	1	16	AX/14-ZA-000-31	200/400 - Trigger	1
4	AX/14-ZA-000-16A	200/400 - Needle Packing Gland	1	17	AX/14-ZA-000-32	200/400 - E Clip	1

SERVICE KITS (Includes all item numbers listed)

Item No.	Product Part Number	Description	Qty
3,4,7,8,9,10,11,17	AX/14-XA-000-06	200/400 - Minor Service Kit	1
3,4,6,7,8,9,10,11,14,17	AX/14-XA-000-07	200/400 - Major Service Kit	1



HOW TO OPERATE

Suggested air pressure is 2.0 to 3.5 bar (29 to 50 psi).

Recommended paint viscosity differs according to paint property and painting conditions. 15 to 23 sec. / Ford #4 is recommendable.

Keep fluid output as low as possible to the extent that the job will not be hindered. It will lead to a better finish with finer atomization.

Set the spray distance from the gun to the work piece within the range of 150-200mm (5.9-7.9 in).

The gun should be held so that it is perpendicular to the surface of the work piece at all times. Then, the gun should move in a straight and horizontal line. Arcing the gun causes uneven painting.

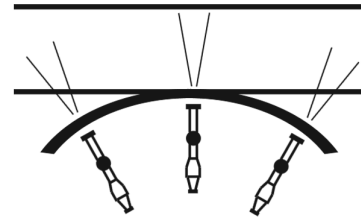

MAINTENANCE AFTER PAINTING







⚠ WARNING

- Turn off air coating material to the gun and release pressure by triggering the gun before disassembling, cleaning or servicing.
 - Pay attention when disassembling spray gun and handling sharp parts.
 - Do not disassemble if unsure of the procedures.
1. Pour remaining paint into another container and then clean paint passages and air cap. Spray a small amount of thinner to clean paint passages. Incomplete cleaning will cause adverse pattern shape and particles. Clean fully and promptly two-component paint after use.
 2. Clean other sections with attached brush soaked with thinner and waste cloth.
 3. Clean paint passages thoroughly before disassembly. Use a spanner or box wrench to remove the fluid nozzle.
 4. Remove fluid nozzle after removing fluid needle set or while keeping fluid needle pulled, in order to protect seat section.
 5. While keeping fluid needle set inserted; tighten fluid needle packing set by hand, then tighten gradually by spanner. Adjust packing set while pulling trigger and watching movement of fluid needle set since too much tightening will slow down movement of fluid needle and result in leakage from tip of nozzle. If tightened too much, turn counterclockwise to a suitable position.
 6. Turn pattern adjustment knob counterclockwise to fully open, and then tighten pattern adjustment guide into gun body.

⚠ CAUTION

- Use only original Atomex spare parts for repairs.
- Never immerse the whole gun into liquid such as thinner.
- Damaging holes of air cap, fluid nozzle and fluid nozzle may lead to degraded performance and/or malfunction.

TROUBLESHOOTING

Spray Pattern	Problems	Fix
Fluttering 	<ol style="list-style-type: none"> 1. Air enters between fluid nozzle and tapered seal of gun body. 2. Air is suctioned from fluid needle packing. 	<ol style="list-style-type: none"> 1. Remove fluid nozzle to clean seat. If it is damaged, replace nozzle. 2. Tighten fluid needle packing.
Crescent 	<ol style="list-style-type: none"> 1. Paint buildup on air cap partially clogs horn holes. Air pressure from both horns differs. 	<ol style="list-style-type: none"> 1. Without using metal objects, remove obstructions from horn holes.
Inclined 	<ol style="list-style-type: none"> 1. Paint buildup on air cap partially clogs horn hole or air cap center hole. 2. Loose fluid nozzle. 	<ol style="list-style-type: none"> 1. Remove obstructions. Replace part if required. 2. Remove fluid nozzle and clean seated section.
Split 	<ol style="list-style-type: none"> 1. Paint viscosity too low. 2. Fluid output too high. 	<ol style="list-style-type: none"> 1. Add paint to increase viscosity. 2. Adjust fluid adjustment knob or patten adjustment knob.
Heavy Centre 	<ol style="list-style-type: none"> 1. Paint viscosity too high. 2. Fluid output too low. 	<ol style="list-style-type: none"> 1. Reduce viscosity. 2. Increase fluid output.
Spit 	<ol style="list-style-type: none"> 1. Fluid nozzle and fluid needle set are not sealed properly. 2. The first-stage travel of trigger (air discharge only) decreases. 3. Paint buildup inside air cap set. 	<ol style="list-style-type: none"> 1. Clean or replace fluid nozzle and fluid needle set. 2. Replace fluid nozzle and fluid needle set. 3. Clean air cap set.