

G40 Air Assisted Spray Gun

311937G

EN

For the application of architectural paints and coatings. For professional use only.

Model: 288513, 289604

Maximum Working Pressure: 4000 psi (280 bar, 28 MPa)

Maximum Air Working Pressure: 100 psi (7 bar, 0.7 MPa)



IMPORTANT SAFETY INSTRUCTIONS. Refer to your sprayer instruction manual for Pressure Relief, priming and spray instructions. Keep these instructions.

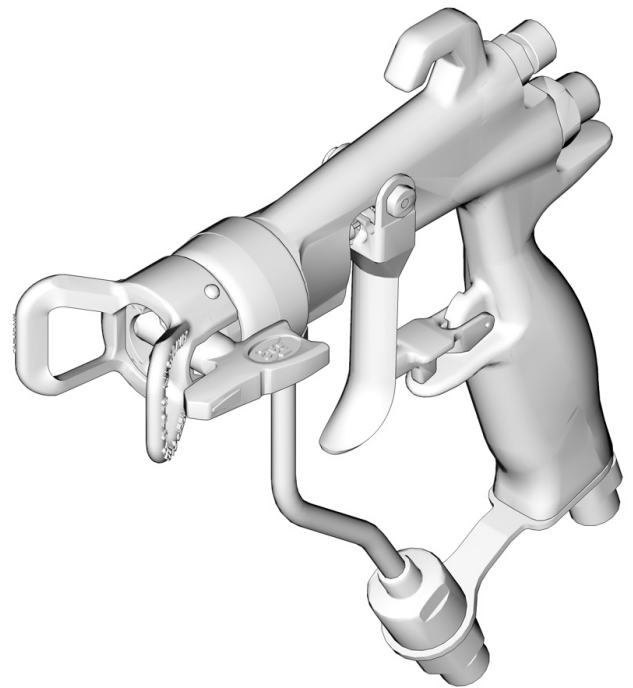

ti8835a



Warnings

The following Warnings are for the setup, use, grounding, maintenance and repair of this equipment. The exclamation point symbol alerts you to a general warning and hazard symbols refer to procedure-specific risks. Refer back to these Warnings. Additional, product-specific warnings may be found throughout the body of this manual where applicable.

WARNING



SKIN INJECTION HAZARD

High-pressure fluid from gun, hose leaks, or ruptured components will pierce skin. This may look like just a cut, but it is a serious injury that can result in amputation. **Get immediate surgical treatment.**

- Do not point gun at anyone or at any part of the body.
- Do not put your hand over the spray tip.
- Do not stop or deflect leaks with your hand, body, glove, or rag.
- Do not spray without tip guard and trigger guard installed.
- Engage trigger lock when not spraying.

Follow **Pressure Relief Procedure** in this manual, when you stop spraying and before cleaning, checking, or servicing equipment.



FIRE AND EXPLOSION HAZARD

Flammable fumes, such as solvent and paint fumes, in **work area** can ignite or explode. To help prevent fire and explosion:

- Use equipment only in well ventilated area.
- Eliminate all ignition sources; such as pilot lights, cigarettes, portable electric lamps, and plastic drop cloths (potential static arc).
- Keep work area free of debris, including solvent, rags and gasoline.
- Do not plug or unplug power cords, or turn power or light switches on or off when flammable fumes are present.
- Ground all equipment in the work area. See **Grounding** instructions.
- Use only grounded hoses.
- Hold gun firmly to side of grounded pail when triggering into pail.
- If there is static sparking or you feel a shock, **stop operation immediately**. Do not use equipment until you identify and correct the problem.
- Keep a working fire extinguisher in the work area.



EQUIPMENT MISUSE HAZARD

Misuse can cause death or serious injury.

- Do not operate the unit when fatigued or under the influence of drugs or alcohol.
- Do not exceed the maximum working pressure or temperature rating of the lowest rated system component. See **Technical Data** in all equipment manuals.
- Use fluids and solvents that are compatible with equipment wetted parts. See **Technical Data** in all equipment manuals. Read fluid and solvent manufacturer's warnings. For complete information about your material, request MSDS forms from distributor or retailer.
- Check equipment daily. Repair or replace worn or damaged parts immediately with genuine manufacturer's replacement parts only.
- Do not alter or modify equipment.
- Use equipment only for its intended purpose. Call your distributor for information.
- Route hoses and cables away from traffic areas, sharp edges, moving parts, and hot surfaces.
- Do not kink or over bend hoses or use hoses to pull equipment.
- Keep children and animals away from work area.
- Comply with all applicable safety regulations.

! WARNING**PRESSURIZED ALUMINUM PARTS HAZARD**

Do not use 1,1,1-trichloroethane, methylene chloride, other halogenated hydrocarbon solvents or fluids containing such solvents in pressurized aluminum equipment. Such use can cause serious chemical reaction and equipment rupture, and result in death, serious injury, and property damage.

**PERSONAL PROTECTIVE EQUIPMENT**

You must wear appropriate protective equipment when operating, servicing, or in the operating area of the equipment to help protect you from serious injury. This equipment includes but is not limited to:

- Protective eyewear
- Clothing and respirator as recommended by the fluid and solvent manufacturer
- Gloves
- Hearing protection

Pressure Relief Procedure



Follow this **Pressure Relief Procedure** whenever instructed to relieve pressure, stop spraying, check or service equipment, or install or clean spray tip.

1. Lock trigger. Turn OFF power and turn pressure control to lowest pressure setting.
2. Unlock trigger. Hold gun against side of flushing pail. Trigger gun into pail to relieve pressure.

If you suspect spray tip or hose is clogged or that pressure has not been fully relieved after following the steps above, **VERY SLOWLY** loosen tip guard retaining nut or hose end coupling to relieve pressure gradually, then loosen completely. Clear hose or tip obstruction.

Gun Trigger Lock



To prevent injury when the gun is not in use, always lock the trigger if unit is being shut down or left unattended.

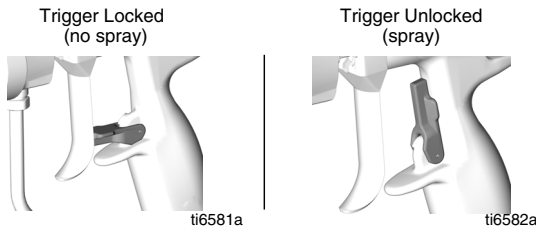

Setup

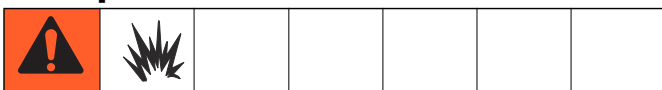

Make sure sprayer is turned off and unplugged from power source and trigger lock is locked. Refer to your sprayer instruction manual for priming and spray instructions.

Connect Gun to Sprayer

1. Attach air inlet fitting (17) and fluid inlet fitting (25) to gun.

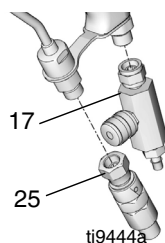

2. For Air-Assisted spraying, **first** attach black, coiled, air supply hose (a) to gun air inlet fitting (17).

NOTE: The first time you set up the gun for spraying you will have to cut the black air hose to length desired.

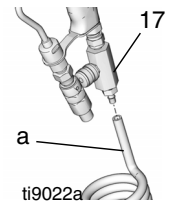

3. Attach blue fluid supply hose (b) to gun fluid inlet fitting (25).
4. Attach other end of air and fluid supply hoses to sprayer. Use two wrenches to tighten all connections securely (see sprayer setup instructions in sprayer operation manual 311905.)

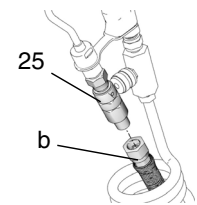

Installing Tip (33) and Guard (6) on Gun

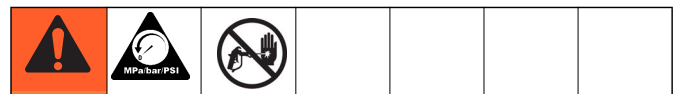

1. If equipment has recently been operated, **relieve pressure.**

2. Insert seat housing (35) into guard (6).
3. Insert SwitchTip (33).
4. Insert seal (33b) over seat (35a) and insert in seat housing (25). Use black seal for water-based materials and orange for solvent and oil-based materials.
5. Install guard (6) over end of gun. Hand tighten.

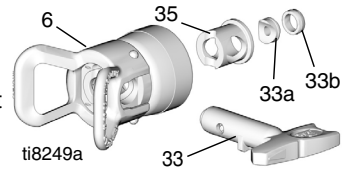

If you notice fluid leaking from front of gun, replace the seat (33a) and/or retighten the guard nut.

Operation

Note: The following instructions are for guns used with Graco's FinishPro Sprayers. See the sprayer instruction manual 311905. If you are using a different sprayer, see your equipment instruction manual.

If you are using a FinishPro™ 390 Model Sprayer, air regulation is only provided at the gun. The FinishPro™ 390 Model Sprayers provide additional air regulation at the sprayer.

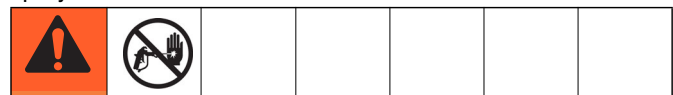

1. Unlock trigger (1a).
2. Be sure the arrow shaped tip (33) faces forward (spray).
3. Hold gun perpendicular and approximately 12-inches (304 mm) from surface. Move gun first, then pull gun trigger (3) to spray a test pattern.
4. Always hold gun at a right angle from the surface. Do not make an arc with the gun. This causes an uneven coat of fluid. To obtain an even finish, use smooth, even strokes across the object being sprayed with a 50% overlap.

Clearing a Clog

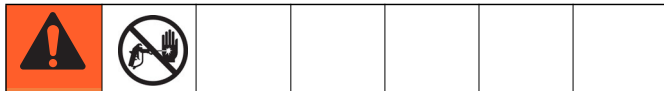

1. **Relieve pressure.** Lock trigger (1a).
2. Rotate tip (33) 180°. Unlock trigger (1a). Trigger gun into pail or onto ground to remove clog.
3. Lock trigger (1a). Rotate tip (33) 180° back to spray position.

Spraying

Refer to your Sprayer Instruction manual. The following instructions are for guns used with Graco's FinishPro Sprayers.



Air-Assisted Spraying

1. Set sprayer function selection switch to **AIRLESS** spraying.
2. Open gun air pressure regulator all the way.
3. Prime pump following priming instructions provided in sprayer operation manual 311905.
4. Turn sprayer fluid pressure control to highest setting.
5. Unlock trigger (1a). While triggering gun, turn down sprayer fluid pressure until you notice tails forming in spray pattern.
6. Stop triggering gun.
7. Set sprayer toggle switch to **AA (Air Assisted)** spraying.
8. Trigger gun. While spraying increase gun air pressure regulator until tails disappear.
9. Use gun air regulator to fine tune spray pattern.

Airless Spraying

1. Set sprayer function selection switch to **AIRLESS** spraying.
2. Prime pump following priming instructions provided in sprayer operation manual 311905.
3. Start with sprayer pressure turned to lowest setting.
4. Spray a test pattern. Gradually increase sprayer pressure until you achieve a consistent spray pattern, without heavy edges. Use a smaller tip if pressure adjustment alone does not eliminate edges.

Note: If you are getting an irregular spray pattern, clean air holes with solvent and a soft brush or toothpick. Do not use metal tools to clean the air cap holes as this may scratch them. Scratches can distort the spray pattern.

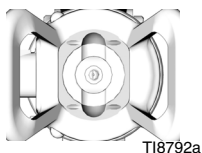

T18792a

Maintenance



Before performing any maintenance on gun, read all warnings on front cover of this manual and **relieve pressure**, page 4.

Daily Maintenance

Flush gun after each work shift and store in a dry location.

Do not immerse the gun or any parts in water or cleaning solvents.

- Do not point gun up while cleaning it.
- Do not wipe gun with cloth soaked in solvent; wring out excess.
- Solvent left in gun air passages could result in a poor quality paint finish. Do not use any cleaning method that may allow solvent into gun air passages.

Flushing and Cleaning

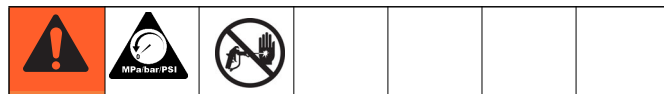

- Flush gun before changing colors, before storing and before repairing gun.
 - Flush at lowest possible pressure. Check connectors for leaks and tighten as necessary.
 - Flush with fluid that is compatible with fluid being dispensed and equipment's wetted parts.
1. **Relieve pressure**, page 4. Unplug sprayer from outlet.
 2. Remove tip (33) and guard (6).
 3. Disconnect black air supply hose from gun.
 4. Remove sprayer siphon tube set from paint and place in flushing fluid. See Cleanup instructions in sprayer operation manual 311905.
 5. Plug sprayer in outlet. Set sprayer function selection switch to AIRLESS.
 6. Increase pressure slowly. Point gun down into a grounded metal container. Pull gun trigger and flush gun with solvent until all traces of fluid are removed from gun passages.
 7. Turn sprayer function selection switch to OFF.
 8. **Relieve pressure**, page 4.
 9. Disconnect fluid supply hose from gun.
 10. If it is necessary to remove diffuser (5) to clean, trigger gun while you remove the diffuser with the gun tool (30).
 11. Dip the soft end of a soft-bristle brush into a compatible solvent. **Do not continuously soak the brush's bristles with solvent and do not use a wire brush.**
 12. With gun pointed down, clean front of the gun with the soft-bristle brush and solvent.
 13. Scrub the tip (33) and guard (6) with soft-bristle brush. To clean out air cap holes, use a soft tool such as a toothpick, to avoid damaging critical surfaces. Blow air through the spray tip to ensure the orifice is clean.

Warnings

- If the diffuser (5) was removed, trigger the gun while you reinstall the diffuser with the gun tool (30). Tighten the diffuser securely to obtain a good seal. Torque to 155-165 in-lb (18-19 N.m). When properly tightened, the flange will bottom out on the gun.
- Install tip (33) and guard (6) on gun, page 4.
- Using a soft cloth dampened in solvent, wipe off outside of gun.
- After cleaning, lubricate the following parts weekly with lubricant 111265.
 - Trigger pivot pin (A)
 - Both sides of gun where trigger contacts gun (B)
 - Fluid needle shaft, behind trigger (C)

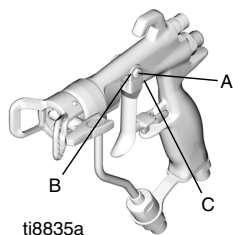

Cleaning/Replacing Filter (24)



- Relieve pressure, page 4. Lock trigger (1a).
- Unscrew fluid inlet fitting (25).
- Remove inline fluid filter (24).
- Clean filter with soft brush and compatible solvent. Inspect filter and if damaged, replace it.
- Install inline fluid filter (24) into base of fluid tube (16).
- Screw fluid inlet fitting (25) into base of tube. Torque to 175-185 in-lb (20-21 N•m).

Repair



Seat Repair

Use Carbide Seat Repair Kit - 249456. For best results use all new parts provided in kit.

- Relieve the pressure, page 4. Remove the fluid and air hoses from the gun.
- Remove the guard (6) and spray tip (33).
- Trigger gun to pull the needle housing off the seat while you unscrew the diffuser (5) from the gun body (1), using gun tool (30).
- Inspect o-rings (5e, 5f, and 6a) in place. Carefully remove the o-rings from the diffuser housing (5a) and replace if necessary.
- Remove the seat nut (5d), seat (5c) and seat gasket (5b) using a 7/32 in. hex wrench.
- Inspect seat (5c) and seat gasket (5b) and replace if necessary.
- Reinstall the seat gasket (5b) seat (5c) and seat nut (5d). Torque to 45-50 in-lb (5.0-5.6 N•m). Be sure not to overtighten nut.
 - When reinstalling the carbide seat (5c), the tapered end of the seat must point toward the gun tip.

Needle Repair (2)

- Relieve pressure, page 4. Remove the diffuser (5), see Seat Repair, page 6.
- Remove the trigger pivot pin nut (14), pivot pin (13), and trigger (3) using the gun tool (30) and nut driver (29).

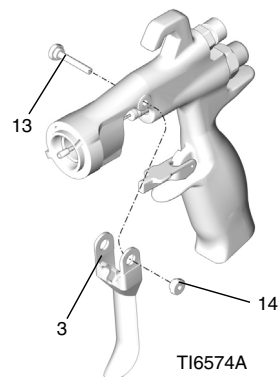

- Remove the fluid needle assembly (2) from the front of the gun by using the nut driver tool (29). If the needle is bent or damaged, or the packing is worn or leaking, replace the entire needle assembly. If replacement is necessary, be sure to remove the o-ring (2a) as it may stick inside the gun body.

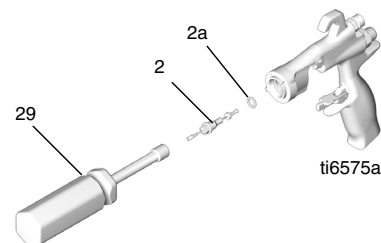

Air Valve Repair (8)

- Unscrew the spring cap (11) from the back of the gun body (1) using the gun tool (30). Remove the two springs (15 and 19), the shaft (9), and seat (10).
- Push the air valve assembly (8) out the back of the gun.
- Inspect the u-cup (7) in the gun body (1). If the u-cup is worn or leaking, carefully remove the u-cup from the front of the gun body, using a pick.

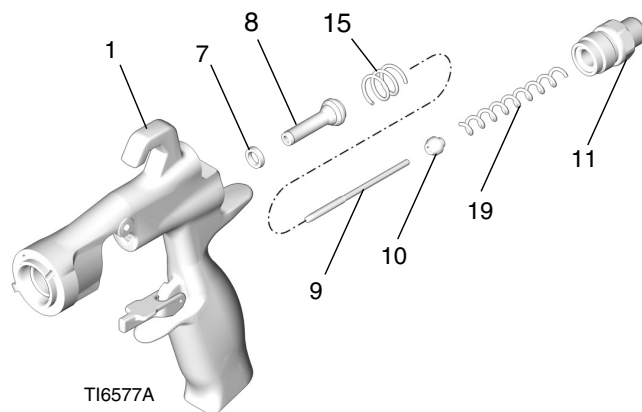

Fluid Tube Replacement (16)

1. Remove the air inlet fitting (17) using the gun tool (30) and remove the screw (20) using a 3/16 in. hex wrench.
2. Unscrew the fluid inlet fitting (25). Remove and clean or replace the inline fluid filter (24).
3. Unscrew fluid tube connector (16a) from fluid inlet. Carefully remove gasket (22).

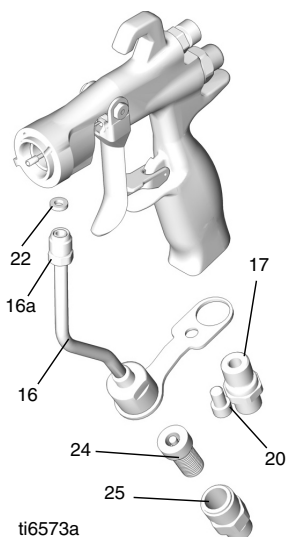

Flat Tip Conversion Kit (Optional)

The Flat Tip Conversion Kit allows AAM Flat Tips to be used with this gun. Order part number 288514.

Reassembly

1. Install the tube gasket (22) in the gun. Hand tighten the fluid tube connector (16a) into the gun's fluid inlet. Antigen the air inlet fitting (17) and screw (20). Torque the fluid tube connector to 150-160 in-lb (17-18 N•m). Torque the air inlet fitting to 175-185 in-lb (20-21 N•m). Torque the fluid tube bracket screw to 50-60 in-lb (6-7 N•m).
2. Install the inline fluid filter (24) into the base of the fluid tube (16). Screw the fluid inlet fitting (25) into the base of the tube. Torque to 175-185 in-lb (20-21 N•m).
3. Place the new u-cup (7) on the seal installation tool (28), with the u-cup lips facing the tool. Push the u-cup into the back of the gun until you feel a definite snap.

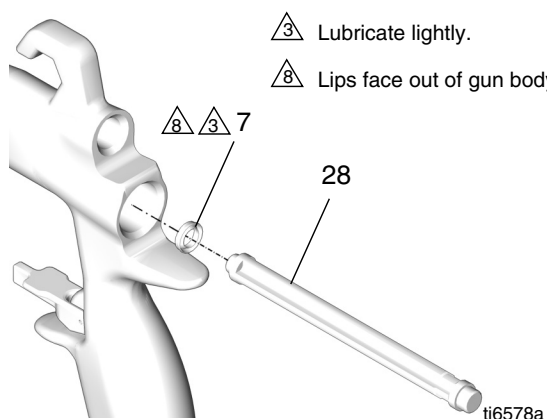

4. Lubricate the front end of the air valve assembly (8). Gently slide the air valve assembly into the back of the gun, passing through the u-cup (7), as far as it will go. Be careful not to damage the u-cup.
5. Slide the seat (10) onto the shaft (9). Be sure that the tapered end of the seat is toward the thicker end of the shaft. Carefully insert the shaft (9) and seat (10) in the air valve (8).

6. Install the two springs (15 and 19). Screw the spring cap (11) into the back of the gun body. Torque to 175-185 in-lb (20-21 N•m).
7. Lightly lubricate the needle assembly o-rings and shaft where the packing slides. Be sure that the o-ring (2a) is in place in the gun body (1).
8. Insert the fluid needle assembly (2) into the front of the gun. Use the nut driver (29) to screw the fluid needle assembly into the gun body (1) and torque to 50-60 in-lb (6-7 N•m).

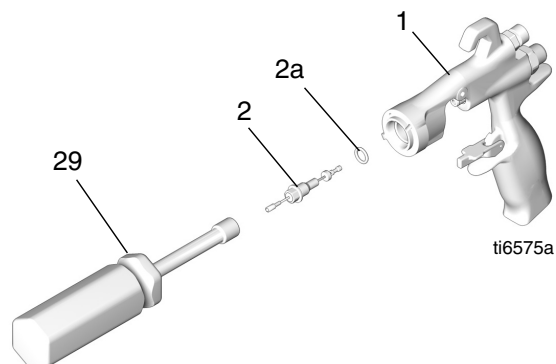

9. Install the trigger (3), pivot pin (13), and nut (14). Use low strength thread locker and be sure that the brass piece of the fluid needle assembly (2) is behind the trigger. Lubricate both sides of the pivot pin where the trigger contacts the pin and lubricate the boss on both sides of the gun where the trigger contacts the gun body. Torque the nut to 20-30 in-lb (2-3 N•m).
10. Trigger the gun to pull the needle back while you screw the diffuser assembly (5) into the gun body (1) using the gun tool (30). Torque to 155-165 in-lb (18-19 N•m). When properly tightened, the flange will bottom out on the gun.
11. Attach the guard (6) and spray tip (33), page 4.

Translated Manuals

Spanish - 311939	Estonian - 311957
French - 311938	Latvian - 311958
Dutch - 311941	Lithuanian - 311956
German - 311950	Polish - 311951
Italian - 311940	Hungarian - 311954
Turkish - 311942	Czech - 311953
Greek - 311943	Slovakian - 311959
Croatian - 311955	Portuguese - 311944
Danish - 311948	Finnish - 311946
Chinese - 311960	Swedish - 311947
Japanese - 311961	Norwegian - 311949
Korean - 311962	Russian - 311952

Translated manuals can be obtained from a distributor or by visiting www.graco.com.

Parts

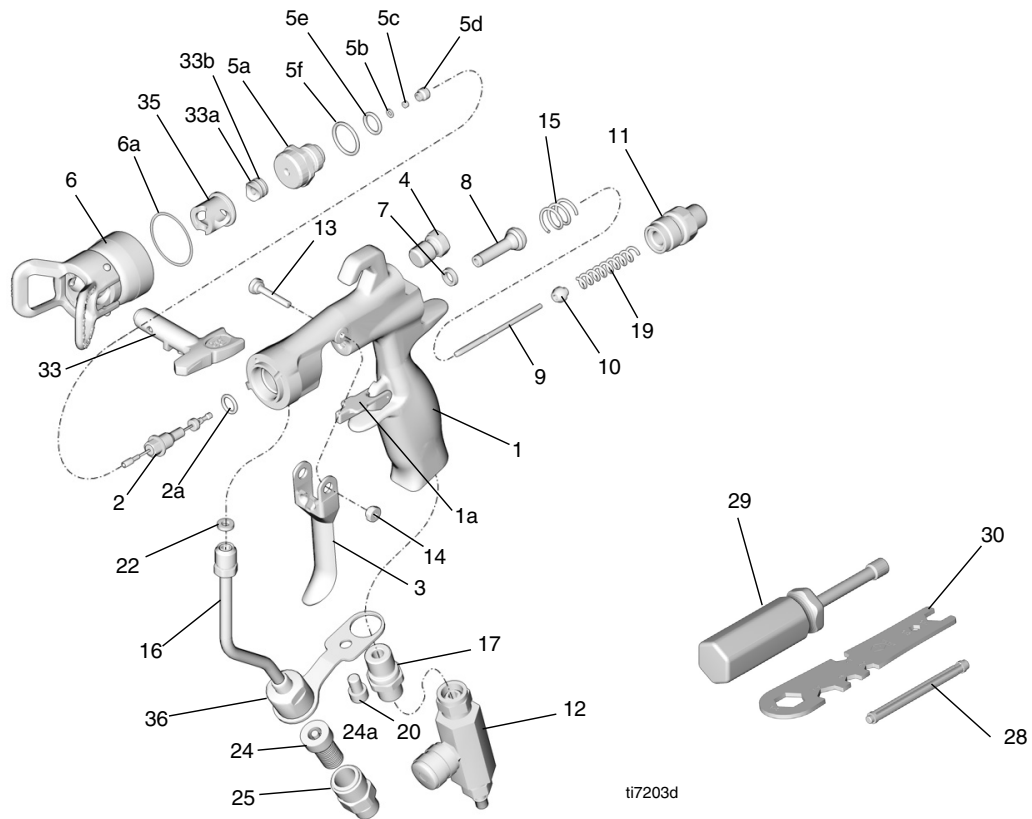

Ref.	Part No.	Description	Qty.
1		BODY, gun, assy	1
1a	249423	SAFETY, trigger	1
2◆		NEEDLE, assy; 3/32 carbide ball; includes item 2a	1
2a*	110004	PACKING, o-ring; PTFE	1
3	249585	KIT, trigger, repair, includes 13 and 14	1
4	15G713	NUT, air plug	1
5	249877	DIFFUSER, assy, RAC	1
5a		DIFFUSER, housing	1
5b◆		GASKET, seat; nylon	1
5c◆		SEAT; carbide	1
5d◆		NUT, seat	1
5e*	111457	PACKING, o-ring, seat; PTFE	1
5f*	109450	PACKING, o-ring; PTFE	1
6	288839	GUARD, RAC	1
6a*	109213	PACKING, o-ring, PTFE	1
7*	188493	PACKING, u-cup, gun; UHMWPE	1
8*		VALVE, air, assy	1
9	15F193	SHAFT, fluid spring	1
10	15F194	SEAT, spring	1
11	15F195	CAP, spring	1
12	288715	VALVE, swivel with hose fitting	1
13	15F739	PIN, pivot	1
14	15F740	PIN, pivot, nut	1
15	114069	SPRING, compression	1
16	249136	TUBE, assy	1
17	15F202	FITTING, air inlet	1
19	115141	SPRING, compression	1
20	119996	SCREW, cap, socket hd; 1/4-20 x 3/8 in. (10 mm)	1

Ref.	Part No.	Description	Qty.
22*	115133	GASKET, tube, acetal	1
24	224453	FILTER	1
24a‡	162863	GASKET, non-metallic (sold separately)	1
25	15F186	FITTING, fluid inlet	1
28*		TOOL, installation; seal	1
29	117642	TOOL, nut driver	1
30	15F446	TOOL, gun	1
31▲	222385	CARD, warning (not shown)	1
32▲	172479	TAG, warning (not shown)	1
33	FFT210	SPRAY TIP (288513)	1
	FFA210	SPRAY TIP (289604)	1
33a**		SEAT, gasket	1
33b**		SEAL	1
35†	15J770	HOUSING, cylinder	1
36	239663	SWIVEL	1

▲ Replacement Danger and Warning labels, tags, and cards are available at no cost.
 ◆ Included in Needle/Seat Repair Kit 255160 (purchase separately)
 † Included in RAC Guard Kit 288839
 *Included in Seal Repair Kit 249422 (purchase separately)
 ‡ If you want to remove the filter, order 162863 to use as a seal in its place.
 **Included in 246453 RAC X One Seal Kit (Standard)
 **Included in 248936 RAC X One Seal Kit (Solvent)

Technical Data

Maximum Working Fluid Pressure.....	4000 psi (28 MPa, 280 bar)
Maximum Working Air Pressure.....	100 psi (0.7 MPa, 7 bar)
Maximum Working Fluid Temperature.....	110° F (43° C)
Fluid inlet.....	1/4-18 npsm
Air Inlet.....	1/4-18 npsm
Gun Weight.....	16 oz (450 grams)
Sound Pressure*: 20 psi (140 kPa, 1.4 bar).....	66.9 dB(A)
Sound Pressure*: 100 psi (0.7 kPa, 7 bar).....	80.0 dB(A)
Sound Power*: 20 psi (140 kPa, 1.4 bar).....	76.8 dB(A)
Sound Power*: 100 psi (0.7 kPa, 7 bar).....	89.9 dB(A)
Wetted Parts: Stainless Steel, Carbide, Ultra High Molecular Weight Polyethylene, Acetal, PTFE, Nylon, Fluoroelastomer	

*All readings were taken with fan valve fully closed, (full fan size) at 20 psi (140 kPa, 1.4 bar) and 100 psi (0.7 kPa, 7 bar) and at the assumed operator position. Sound Power tested to ISO 9614-2.

Graco Standard Warranty

Graco warrants all equipment referenced in this document which is manufactured by Graco and bearing its name to be free from defects in material and workmanship on the date of sale to the original purchaser for use. With the exception of any special, extended, or limited warranty published by Graco, Graco will, for a period of twelve months from the date of sale, repair or replace any part of the equipment determined by Graco to be defective. This warranty applies only when the equipment is installed, operated and maintained in accordance with Graco's written recommendations.

This warranty does not cover, and Graco shall not be liable for general wear and tear, or any malfunction, damage or wear caused by faulty installation, misapplication, abrasion, corrosion, inadequate or improper maintenance, negligence, accident, tampering, or substitution of non-Graco component parts. Nor shall Graco be liable for malfunction, damage or wear caused by the incompatibility of Graco equipment with structures, accessories, equipment or materials not supplied by Graco, or the improper design, manufacture, installation, operation or maintenance of structures, accessories, equipment or materials not supplied by Graco.

This warranty is conditioned upon the prepaid return of the equipment claimed to be defective to an authorized Graco distributor for verification of the claimed defect. If the claimed defect is verified, Graco will repair or replace free of charge any defective parts. The equipment will be returned to the original purchaser transportation prepaid. If inspection of the equipment does not disclose any defect in material or workmanship, repairs will be made at a reasonable charge, which charges may include the costs of parts, labor, and transportation.

THIS WARRANTY IS EXCLUSIVE, AND IS IN LIEU OF ANY OTHER WARRANTIES, EXPRESS OR IMPLIED, INCLUDING BUT NOT LIMITED TO WARRANTY OF MERCHANTABILITY OR WARRANTY OF FITNESS FOR A PARTICULAR PURPOSE.

Graco's sole obligation and buyer's sole remedy for any breach of warranty shall be as set forth above. The buyer agrees that no other remedy (including, but not limited to, incidental or consequential damages for lost profits, lost sales, injury to person or property, or any other incidental or consequential loss) shall be available. Any action for breach of warranty must be brought within two (2) years of the date of sale.

GRACO MAKES NO WARRANTY, AND DISCLAIMS ALL IMPLIED WARRANTIES OF MERCHANTABILITY AND FITNESS FOR A PARTICULAR PURPOSE, IN CONNECTION WITH ACCESSORIES, EQUIPMENT, MATERIALS OR COMPONENTS SOLD BUT NOT MANUFACTURED BY GRACO. These items sold, but not manufactured by Graco (such as electric motors, switches, hose, etc.), are subject to the warranty, if any, of their manufacturer. Graco will provide purchaser with reasonable assistance in making any claim for breach of these warranties.

In no event will Graco be liable for indirect, incidental, special or consequential damages resulting from Graco supplying equipment hereunder, or the furnishing, performance, or use of any products or other goods sold hereto, whether due to a breach of contract, breach of warranty, the negligence of Graco, or otherwise.

FOR GRACO CANADA CUSTOMERS

The Parties acknowledge that they have required that the present document, as well as all documents, notices and legal proceedings entered into, given or instituted pursuant hereto or relating directly or indirectly hereto, be drawn up in English. Les parties reconnaissent avoir convenu que la rédaction du présente document sera en Anglais, ainsi que tous documents, avis et procédures judiciaires exécutés, donnés ou intentés, à la suite de ou en rapport, directement ou indirectement, avec les procédures concernées.

Graco Information

For the latest information about Graco products, visit www.graco.com.

TO PLACE AN ORDER, contact your Graco distributor or call 1-800-690-2894 to identify the nearest distributor.

*All written and visual data contained in this document reflects the latest product information available at the time of publication.
Graco reserves the right to make changes at any time without notice.*

For patent information, see www.graco.com/patents

Original instructions. This manual contains English. MM 311937

Graco Headquarters: Minneapolis

International Offices: Belgium, China, Japan, Korea

GRACO INC. AND SUBSIDIARIES • P.O. BOX 1441 • MINNEAPOLIS MN 55440-1441 • USA

Copyright 2006, Graco Inc. All Graco manufacturing locations are registered to ISO 9001.

www.graco.com
Revised 5/2013