

Fine Finish Hand-Held Paint Sprayer

3A1698F
EN

- For portable spray applications of architectural paints and coatings only -
- Not approved for use in explosive atmosphere locations -
- Service only at Graco approved service centers -
- For professional use only -



IMPORTANT SAFETY INSTRUCTIONS

Read all warnings and instructions in this manual. Save these instructions.

All Models:

Maximum Working Pressure 1700 psi (117 bar, 11.7 MPa)

Model	ETL Intertek	CE	✓
16F887	✓		
16H240	✓		
16H241		✓	✓
16H242		✓	✓
16H243		✓	
262612		✓	
16H245		✓	
16H829		✓	

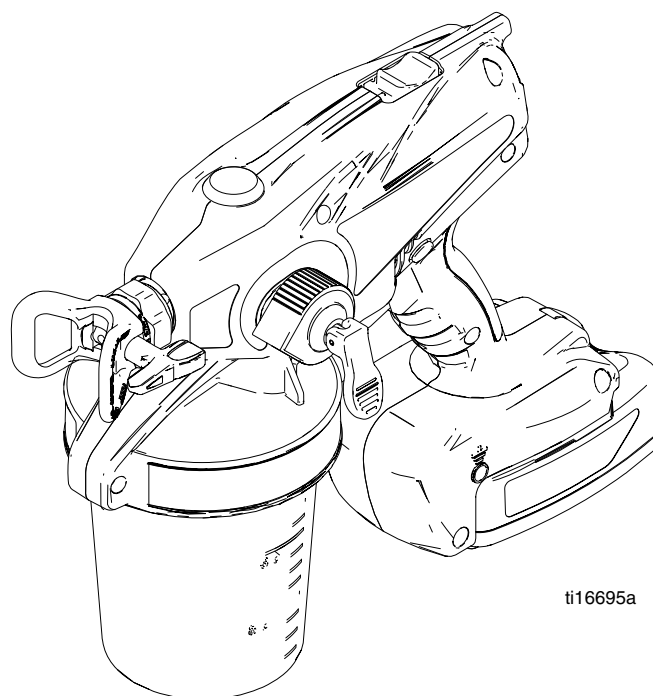

ti16695a

Table of Contents

Warnings	3	Getting Started with Basic Techniques	14
Grounding Instructions	3	Triggering Sprayer	14
Component Identification	7	Aiming Sprayer	14
Charging the Battery	8	Unclogging Spray Tip/Guard Assembly	15
Charger Status Indicator Lights	8	Shutdown and Cleaning	16
Sprayer Status Indicator	8	Flushing Sprayer	16
Common Procedures	9	Cleaning Sprayer Exterior	18
Trigger Lock	9	Fine Finish Tip Wear	18
Prime/Pressure Relief Valve Position	9	Storage	18
Pressure Relief Procedure	9	Replacement Parts and Kits	19
Spray Tip Position	9	Parts List	20
Setting Hi/Lo Switch (Motor Speed)	10	Alternate Priming Method	23
Adjusting Pressure	10	Inlet Valve Removal/Service	24
Setup	11	Outlet Valve Repair	25
Flexible Suction Tube	11	Troubleshooting	26
Sprayer Setup	12	Technical Data	29
Starting a New Job (or Refilling the Cup)	13	Preferred Material Settings Log	30
Reversible Tip Selection Chart	13	Notes	31
Install Tip/Guard Assembly (if not installed)	14	Graco Standard Warranty	32

Important User Information

Before using your sprayer read this Operation Manual for complete instructions on proper use and safety warnings.

DO NOT RETURN THIS SPRAYER TO THE STORE!

If you experience problems, contact Graco Customer Service at www.graco.com.

Congratulations! You have purchased a high-quality paint sprayer made by Graco Inc. This sprayer is designed to provide superior spray performance with all architectural paints and coatings. This user information is intended to help you understand the types of materials that can be used with your sprayer.

Before using this equipment, be sure to read and follow the information on your container label and ask for a Material Safety Data Sheet (MSDS) from your supplier. The container label and MSDS will explain the contents of the material and the specific precautions related to it.

Paints, coatings and clean-up materials generally fit into one of the following **3 basic categories**:



WATER-BASED: The container label should indicate that the material can be cleaned up with soap and water. Your sprayer is compatible with this type of material. Your sprayer is **NOT** compatible with harsh cleaners such as chlorine bleach.





OIL-BASED: The container label should indicate that the material is combustible and can be cleaned up with mineral spirits or paint thinner. The MSDS must indicate that the flash point of the material is above 100° F. Your sprayer is compatible with this type of material. Use oil-based material outdoors or in a well-ventilated indoor area with a flow of fresh air. See the safety warnings in this manual.



FLAMMABLE: This type of material contains flammable solvents such as xylene, toluene, naphtha, MEK, lacquer thinner, acetone, denatured alcohol, and turpentine. The container label should indicate that this material is **FLAMMABLE**. Your sprayer is compatible with this type of material. Use flammable materials outdoors or in a well-ventilated indoor area with a flow of fresh air. See the safety warnings in this manual.

Warnings

The following warnings are for the setup, use, maintenance, and repair of this equipment. The exclamation point symbol alerts you to a general warning and the hazard symbols refer to procedure-specific risks. When these symbols appear in the body of this manual or on warning labels, refer back to these Warnings. Product-specific hazard symbols and warnings not covered in this section may appear throughout the body of this manual where applicable.

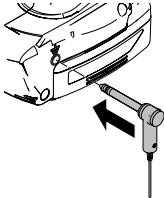
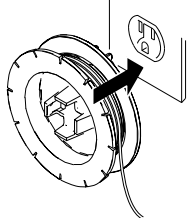
 WARNING	
	<p>FIRE AND EXPLOSION HAZARD (GROUNDING)</p> <p>Some oil-based and flammable materials generate static electricity when sprayed. Static electricity creates an explosion and fire risk. Your sprayer has a grounding cord that will conduct the static electricity to a grounded electrical outlet. The sprayer and all objects in spray area shall be properly grounded to protect against static discharge, sparks or shocks.</p> <ul style="list-style-type: none"> • Connect the grounding cord when spraying flammable or static producing oil-based materials. • If there is static sparking or if you feel a shock, stop spraying immediately and connect the sprayer to a properly grounded electrical outlet with the ground wire provided. <p>GROUNDING INSTRUCTIONS</p> <p>Move the sprayer away from the spray area to a non-hazardous location. Plug the ground wire into the sprayer.</p> 
	<p>Unwind the ground wire from the spool and plug it into a properly grounded electrical outlet.</p> <p>If the ground wire is not long enough to reach a grounded electrical outlet, a 3-wire grounded extension cord may be used to reach a grounded outlet.</p> 

Grounding Wire Repair

If the grounding wire breaks at the **spool end**, perform the following steps:

1. Unwind wire from grounding spool and use a flat screwdriver to pry apart the grounding spool.

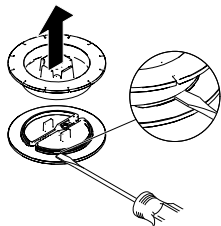

ti17082a

2. Loosen screw on terminal and remove broken wire. Strip insulation from grounding wire, insert into terminal and tighten screw.

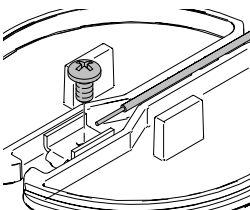

ti17080a

3. Snap the grounding spool back together.

If the grounding wire breaks at the **grounding plug**, perform the following steps:

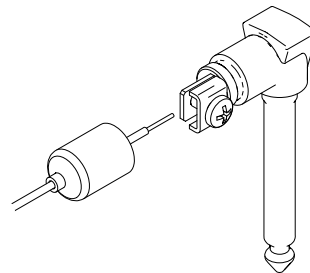

1. Pull rubber boot off of wire at grounding plug and slide boot over grounding wire.







ti17081a

2. Loosen screw and remove broken wire. Insert stripped grounding wire and tighten screw.
3. Replace rubber boot onto grounding plug.

! WARNING

	<p>FIRE AND EXPLOSION HAZARD</p> <p>Flammable fumes, such as solvent and paint fumes, in work area can ignite or explode. To help prevent fire and explosion:</p> <ul style="list-style-type: none"> • Do not spray flammable or combustible liquids in a confined area. • Keep spray area well-ventilated. Keep a good supply of fresh air moving through the area. • Paint or solvent flowing through the sprayer is able to result in static electricity. Static electricity creates a risk of fire or explosion in the presence of paint or solvent fumes. The sprayer and all objects in spray area shall be properly grounded to protect against static discharge, sparks, or shocks. • Always connect the grounding cord provided when spraying flammable materials or static producing oil-based materials. See Grounding Instructions, page 3. • If there is static sparking or you feel a shock, stop operation immediately and connect sprayer to a properly grounded electrical outlet with the ground wire provided. • Do not spray flammable or combustible materials near open flame or sources of ignition such as cigarettes, external motors, and electrical equipment. • Do not operate light switches, engines, or similar spark producing products in the spray area. • Do not smoke in the spray area. • Keep spray area clean and free of paint or solvent containers, rags, and other flammable materials. • Know the contents of the paints and solvents being sprayed. Read all Material Safety Data Sheets (MSDS) and container labels provided with the paints and solvents. Follow the paint and solvents manufacturer's safety instructions. • Fire extinguisher equipment shall be present and working.
	<p>SKIN INJECTION HAZARD</p> <p>High-pressure spray is able to inject toxins into the body and cause serious bodily injury. In the event that injection occurs, get immediate surgical treatment.</p> <ul style="list-style-type: none"> • Do not aim the sprayer at, or spray any person or animal. • Keep hands and other body parts away from the discharge. For example, do not try to stop leaks with any part of the body. • Always engage the trigger lock when not spraying. Verify the trigger lock is functioning properly. • Always use the spray tip guard. Do not spray without spray tip guard in place. • Use caution when cleaning and changing spray tips. In the case where the spray tip clogs while spraying, follow the Pressure Relief Procedure for relieving the pressure before reversing or removing the spray tip to clean. • Do not leave the unit energized or under pressure while unattended. When the unit is not in use, follow the Pressure Relief Procedure and engage the trigger lock. • Check parts for signs of damage. Replace any damaged parts with genuine Graco parts. • This system is capable of producing 1700 psi. Use replacement parts or accessories that are rated a minimum of 1700 psi. • Do not carry the sprayer with a finger on the trigger. • Verify that all connections are secure before operating the unit. • Know how to stop the unit and bleed pressure quickly. Be thoroughly familiar with the controls.

! WARNING

	<p>EQUIPMENT MISUSE HAZARD</p> <p>Misuse can cause death or serious injury.</p> <ul style="list-style-type: none"> • Disconnect the battery before servicing. • Always wear appropriate gloves, eye protection, and a respirator or mask when painting. • Do not operate or spray near children. Keep children away from equipment at all times. • Do not overreach or stand on an unstable support. Keep effective footing and balance at all times. • Stay alert and watch what you are doing. • Do not operate the unit when fatigued or under the influence of drugs or alcohol. • Use only in dry locations. Do not expose to water or rain. • Use in well-lit areas. • Always replace cracked, broken or missing parts immediately with genuine Graco parts. See Parts List, page 19.
	<p>BATTERY HAZARD</p> <p>The battery may leak, explode, cause burns, or cause an explosion if mishandled. Contents of an open battery can cause severe irritation and/or chemical burns. If on skin, wash with soap and water. If in eyes, flush with water for at least 15 minutes and get immediate medical attention.</p> <ul style="list-style-type: none"> • Replace battery only in a well-ventilated area and away from flammable or combustible materials, including paints and solvents. • When battery is not in use, keep it away from metal objects like keys, nails, screws or other metal objects that can short circuit the battery terminals. • When spraying flammable materials, use only Graco SlimLine battery 16G610. Do not use Graco premium battery 16D558 when spraying flammable material. • Do not throw into fire. • Charge only with Graco approved charger as listed in this manual. • Do not store at temperatures below 32° or above 113°F (0° to 45°C). • Do not use at temperatures below 40° or above 90° F (4° to 32°C). • Do not expose battery to water or rain. • Do not disassemble, crush, or penetrate the battery. • Do not use or charge a battery that is cracked or damaged. • Follow local ordinances and/or regulations for disposal.
  	<p>CHARGER ELECTRIC SHOCK, FIRE AND EXPLOSION HAZARD</p> <p>Improper setup or usage can cause electric shock, fire, and explosion.</p> <ul style="list-style-type: none"> • Charge only in a well-ventilated area and away from flammable or combustible materials, including paints and solvents. • Do not charge on a combustible or flammable surface. • Do not leave battery unattended while charging. • Immediately unplug charger and remove battery when charging is complete. • Charge only Graco approved batteries listed in this manual; other batteries may burst. • Use only in dry locations. Do not expose to water or rain. • Do not use a charger that is cracked or damaged. • If the supply cord is damaged, replace the charger or cord, depending on model. • Never force the battery into the charger. • When operating a charger outdoors, always provide a dry location and use an extension cord suitable for outdoor use. • Disconnect the charger from the outlet before cleaning. • Ensure that the outside surface of the battery is clean and dry before plugging into the charger. • Do not attempt to charge non-rechargeable batteries. • Do not disassemble the charger. Take charger to authorized service center when service or repair is required.

! WARNING



PRESSURIZED ALUMINUM PARTS HAZARD

Use of fluids that are incompatible with aluminum in pressurized equipment can cause serious chemical reaction and equipment rupture. Failure to follow this warning can result in death, serious injury, or property damage.

- Do not use 1,1,1-trichloroethane, methylene chloride, other halogenated hydrocarbon solvents or fluids containing such solvents.
- Many other fluids may contain chemicals that can react with aluminum. Contact your material supplier for compatibility.



TOXIC FLUID OR FUMES HAZARD

Toxic fluids or fumes can cause serious injury or death if splashed in the eyes or on skin, inhaled, or swallowed.

- Read MSDS's to know the specific hazards of the fluids you are using.
- Store hazardous fluid in approved containers, and dispose of it according to applicable guidelines.



PERSONAL PROTECTIVE EQUIPMENT

You must wear appropriate protective equipment when operating, servicing, or when in the operating area of the equipment to help protect you from serious injury, including eye injury, hearing loss, inhalation of toxic fumes, and burns. This equipment includes but is not limited to:

- Protective eyewear, and hearing protection.
- Respirators, protective clothing, and gloves as recommended by the fluid and solvent manufacturer.

Component Identification

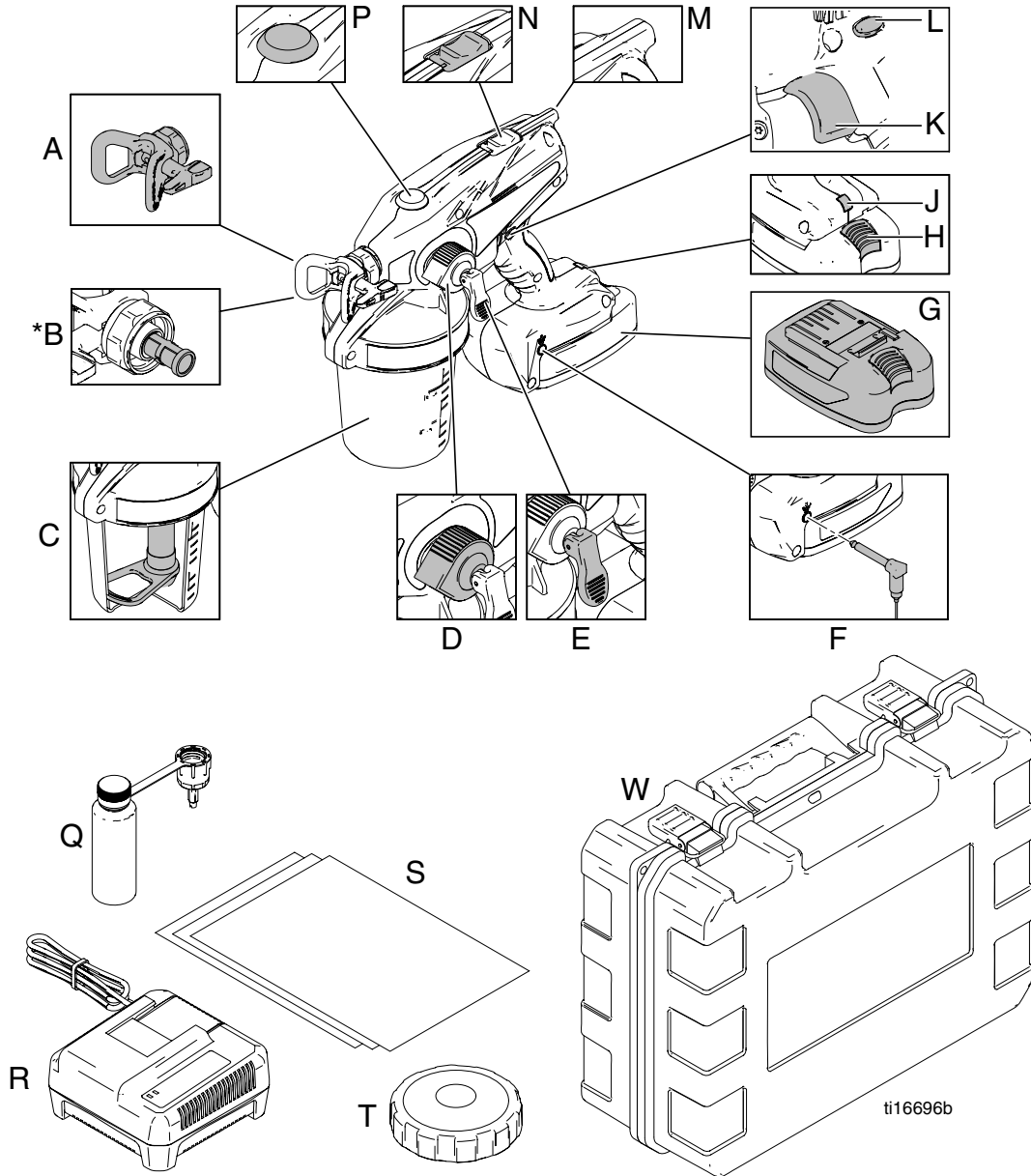

A	Fine Finish Tip/Guard Assembly
*B	Tip Filter (Reverse Threaded)
C	Flexible Suction Tube
D	Pressure Control Knob
E	Prime/Pressure Relief Valve
F	Grounding Plug
G	SlimLine Battery
H	Battery Release Button
J	Indicator Light
K	Trigger

L	Trigger Lock
M	Static Wick
N	Hi/Lo Switch (Motor Speed)
P	Outlet Valve Access Plug
Q	Startup/Storage Kit
R	Lithium Ion Battery Charger
S	Cup Liner Replacement (10 Pack)
T	Cup Lid
W	Storage Case

***NOTE:** Tip filter is reverse-threaded. Turn left (or counter-clockwise) to tighten, turn right (or clockwise) to loosen.

Charging the Battery

	<p>Replace and charge battery only in a well-ventilated area and away from flammable or combustible materials, including paints and solvents.</p>
--	---

Batteries are initially 50% charged to provide optimum battery life and require charging before first use. It takes approximately 25 minutes to charge a dead battery to 80%, at which point it can be used. It will take approximately 40 minutes to fully charge a dead battery.



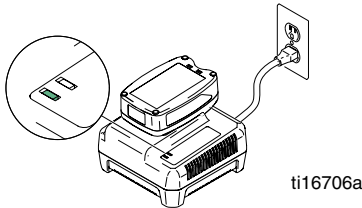

1. Place charger in a dry, well-ventilated area and away from flammable or combustible materials, including paints and solvents.
2. Plug charger into an electrical outlet and slide battery into charger as shown (light will turn on in 5 seconds).



3. When battery becomes fully charged, immediately unplug the charger from the power supply and remove the battery from the charger.

NOTE: The amount sprayed with each battery varies depending on material, tip size, motor speed and pressure setting. Typical results are 1 to 6 cups of material sprayed per battery. Generally you will get longer battery life at higher pressure settings and at low motor speed.

Charger Status Indicator Lights

Label	Appearance	Description
	Solid green light	Indicates a full charge. Battery can be used.
	Flashing green light	Battery is charging, indicates 80% charge. Battery can be used.
	Flashing red light	Battery is charging, indicates less than 80% charge. Do NOT use battery.
	Solid red light	Battery is too hot or too cold to charge. Remove battery and allow to cool or warm up before charging.

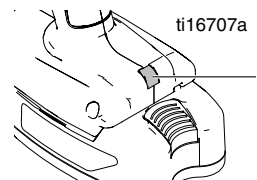

Sprayer Status Indicator

Light*	Appearance	Description
	No light	Normal operation.
	Solid red	Battery is low on power and needs to be charged, or battery is too cold and must warm up before spraying.
	Flashing red	Battery temperature is too high, or tip is clogged. See Troubleshooting , page 26.

*NOTE: The sprayer status indicator light is visible for 10 seconds after the trigger is released.



Common Procedures

Trigger Lock

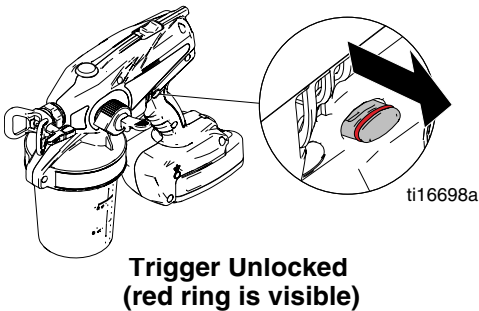
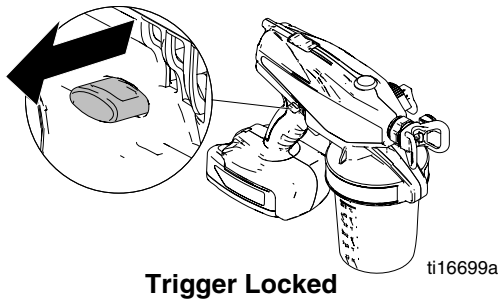
			
<p>Always engage the trigger lock when you stop spraying to prevent the sprayer from being triggered accidentally by hand, or if dropped or bumped.</p>			



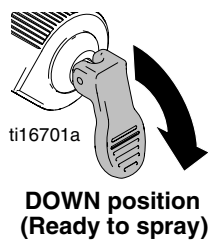
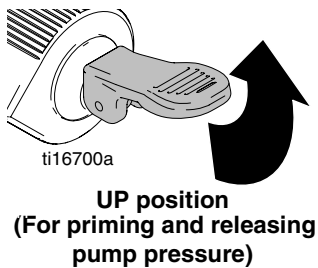

Prime/Pressure Relief Valve Position

			
---	---	---	--



Pressure Relief Procedure

			
<p>Do not operate or spray near children. Do not aim the sprayer at, or spray any person or animal. Keep hands and other body parts away from the front of the sprayer. For example, do not try to stop the paint flow with any part of the body.</p> <p>This sprayer builds up an internal pressure of 1,700 psi during use. Follow this Pressure Relief Procedure whenever you stop spraying and before cleaning, checking, servicing, or transporting equipment to prevent serious injury.</p>			

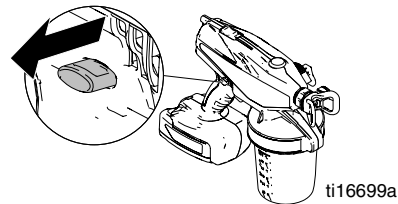

- Engage trigger lock.

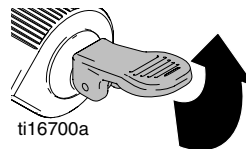

- Put prime/pressure relief valve UP to release pressure.



Spray Tip Position

			
<p>Always perform Pressure Relief Procedure before adjusting spray tip position.</p>			

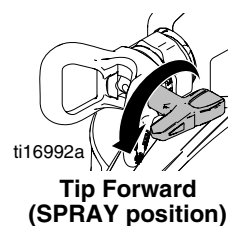

Setting Hi/Lo Switch (Motor Speed)



Low Speed

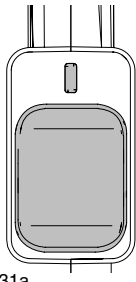

ti16731a

High Speed

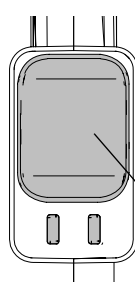

Speed Control
Switch

1. To extend battery life, try spraying with low motor speed to get an acceptable spray pattern.
2. Shift to high speed if needed to achieve an acceptable spray pattern.

Adjusting Pressure

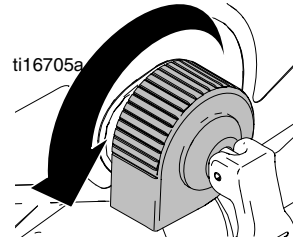

ti16705a

Minimum Pressure Setting

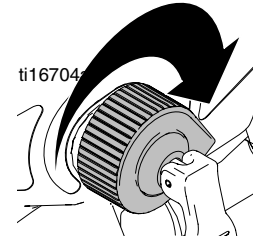



ti16704

Maximum Pressure Setting

1. To reduce overspray, always spray at lowest pressure that results in an acceptable spray pattern.
2. Spray test pattern and adjust pressure to get desired coverage.
3. With some materials, if pressure is set too low, no material may spray out. Turn pressure control up.

Setup

						
---	---	---	--	--	--	--

Flammable fumes (such as solvent and paint fumes) in work area can ignite or explode.

See **Grounding Instructions**, page 3.

Do not spray flammable or combustible liquids in a confined area.

Keep spray area well-ventilated. Keep a good supply of fresh air moving through the area.

NOTICE

Your sprayer is **NOT** compatible with harsh cleaners such as chlorine bleach. Using these cleaners will cause damage to the sprayer.

NOTICE

Do NOT shake materials to be used with this sprayer. Some fine finish lacquers and enamels trap air when shaken, which can affect sprayer performance. Stir the material or check the manufacturer's recommendation for the material being sprayed.

Flexible Suction Tube

This sprayer comes with a suction tube that can be adjusted for multi-directional spraying.

Spraying Ceilings, Walls and Crown Molding

When spraying ceilings or walls, rotate the suction tube collar to the front of the material cup.

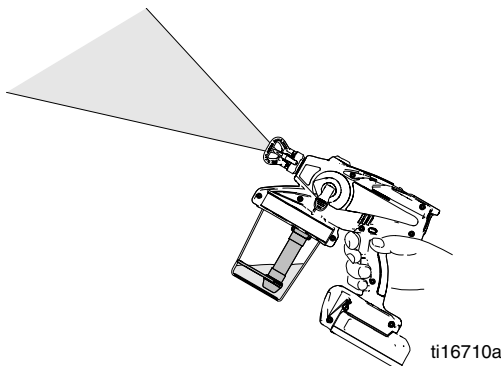

Spraying Floors and Base Boards

When spraying floors, rotate the suction tube collar to the back of the material cup.

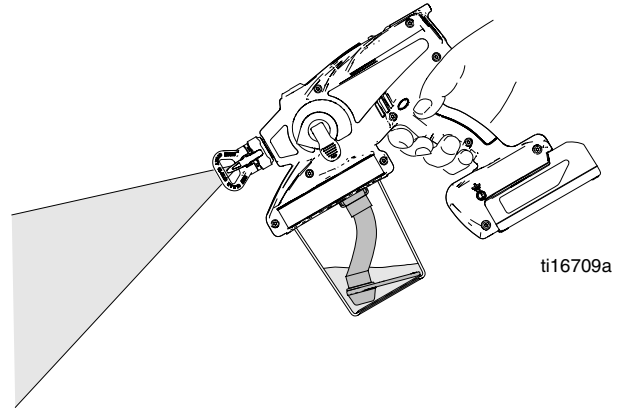

NOTE: If the sprayer is angled or tilted too far, the suction tube will lose contact with the material and the sprayer will stop spraying.

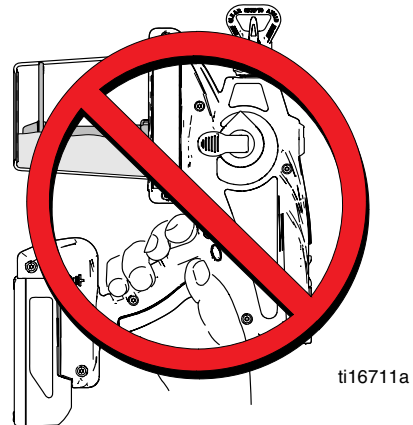

Sprayer Setup

This sprayer arrives from the factory with a small amount of test material in the system. **It is important that you flush this material from the sprayer before using it for the first time:**

1. Fill material cup with water or compatible solvent, thread onto sprayer and hand tighten.



ti16712a

2. Put prime/pressure relief valve to UP position, then hold trigger in for 10 seconds.

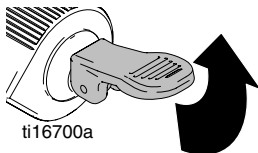

ti16700a

3. Put prime/pressure relief valve DOWN to spray position.

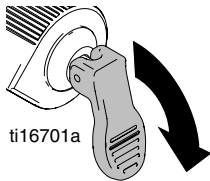

ti16701a

4. Reverse spray tip to UNCLOG position and trigger sprayer into a waste area for 10 seconds.

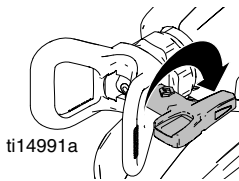

ti14991a

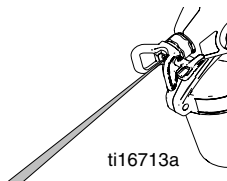

ti16713a

5. Engage trigger lock and put prime/pressure relief valve UP to release pressure.

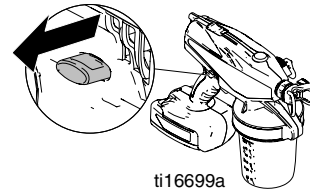

ti16699a

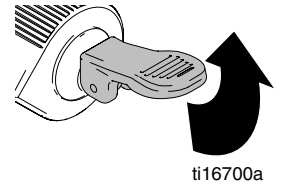

ti16700a

6. Unscrew and remove material cup.
7. Disengage trigger lock, put prime/pressure relief valve DOWN, hold sprayer slightly above material cup, and pull trigger to discharge fluid from pump.

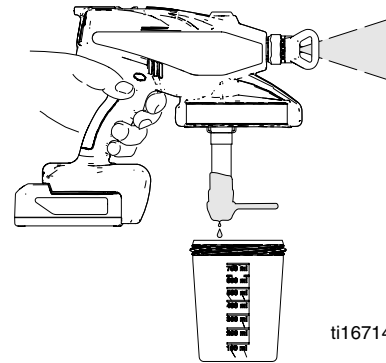

ti16714a

8. Put prime/pressure relief valve UP and pull trigger to finish material flushing.
9. Discard material in cup.

Starting a New Job (or Refilling the Cup)

<p>When spraying flammable or combustible materials:</p> <ul style="list-style-type: none"> Remove entire sprayer from hazardous location when refilling. Always ground the material cup when refilling. Keep material containers covered between cup refills. 		

- Engage trigger lock and put prime/pressure relief valve UP to release pressure.

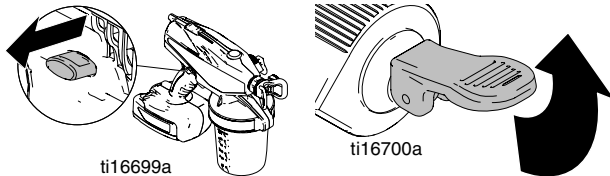

- Install material cup liner, fill with material, and thread onto sprayer.

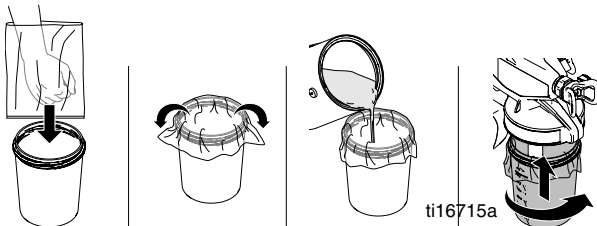

- To prime pump, disengage trigger lock and trigger sprayer for 10 seconds. Then release trigger and put prime/relief valve DOWN to spray position.

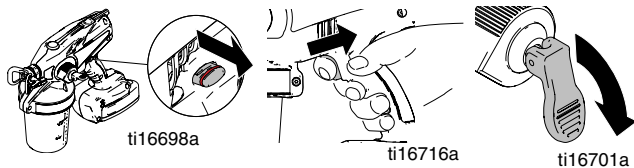

- Reverse spray tip to UNCLOG position and spray into waste area for five seconds.

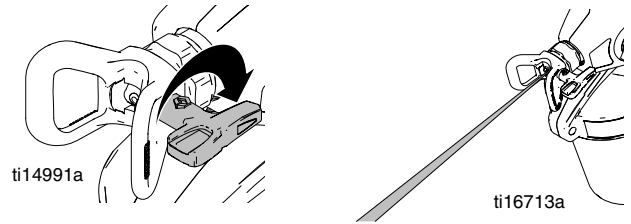

- Put prime/pressure relief valve UP to release pressure. Then rotate tip back to spray position.
NOTE: Failure to perform this operation could result in poor spray pattern.

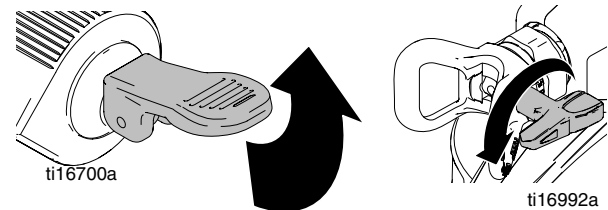

NOTE: If sprayer fails to prime, follow **Alternate Priming Method** (page 23).

Reversible Tip Selection Chart

Fine Finish Materials and Tip Sizes			
Fan Width	THIN Stains	MEDIUM Lacquers, Clears	HEAVY Enamels
4 in. (10 cm)	208	210	
6 in. (15 cm)	308	310	312
8 in. (20 cm)		410	412

Use with all fine finish materials including "hot" solvents.

Install Tip/Guard Assembly (if not installed)

NOTE: Only use Graco Fine Finish Tip/Guard assemblies.



- Engage trigger lock and put prime/pressure relief valve UP to release pressure.

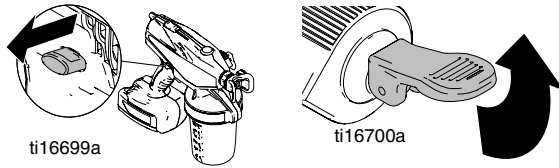

- Install filter to Spray Tip/Guard Assembly. **NOTE:** Filter assembly is reverse-threaded. **Turn left** (or counter-clockwise) to install. **Turn right** (or clockwise) to remove.

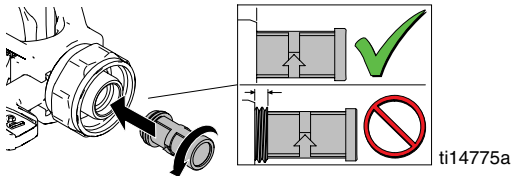

NOTICE

Make sure filter is completely screwed into the Tip/Guard Assembly to avoid damage to the filter. Do not use a damaged filter or poor sprayer performance may result.

- Screw Tip/Guard Assembly onto sprayer. Tighten retaining nut until completely engaged with sprayer. Do not overtighten nut.

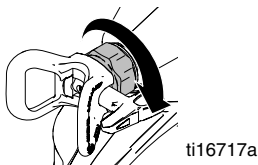

NOTICE

The tip is a permanently attached to the Tip/Guard Assembly. Removal will result in damage.

Getting Started with Basic Techniques

Use a piece of scrap cardboard to practice these basic spraying techniques before you begin spraying the surface.

- Hold sprayer 10 in. (25 cm) from surface and aim straight at surface. Tilting sprayer to direct spray angle causes an uneven finish.



- Flex wrist to keep sprayer pointed straight. Fanning sprayer to direct spray at angle causes uneven finish.

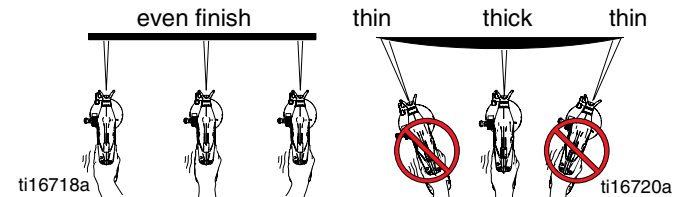

NOTE: How fast you move the sprayer will affect spray application. If material is pulsating, you are moving too fast. If material drips, you are moving too slow. See **Troubleshooting**, page 26.

Triggering Sprayer

Pull trigger after starting stroke. Release trigger before end of stroke. Sprayer must be moving when trigger is pulled and released.

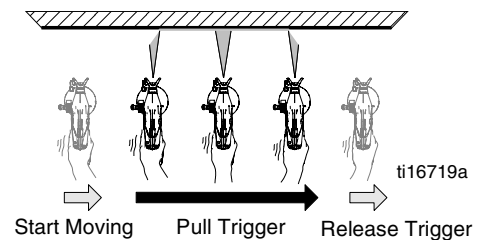

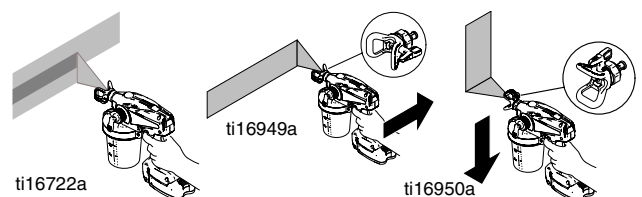

Aiming Sprayer

Aim tip of sprayer at bottom edge of previous stroke, overlapping each stroke by half.



Unclogging Spray Tip/Guard Assembly

							
<p>Do not operate or spray near children. Do not aim the sprayer at, or spray any person or animal. Keep hands and other body parts away from the discharge. For example, do not try to stop leaks with any part of the body.</p>							

1. To unclog tip obstruction, engage trigger lock and put prime/pressure relief valve UP to release pressure.

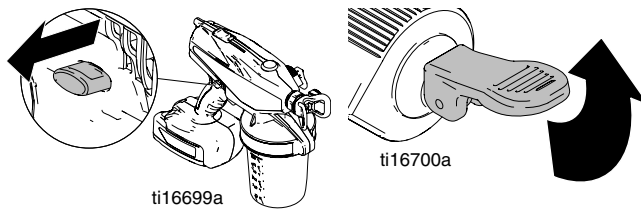

2. Reverse spray tip to UNCLOG position.

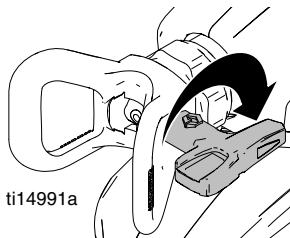

3. Aim sprayer at waste area, disengage trigger lock, and put prime/pressure relief valve DOWN to spray position. Pull trigger to clear clog.

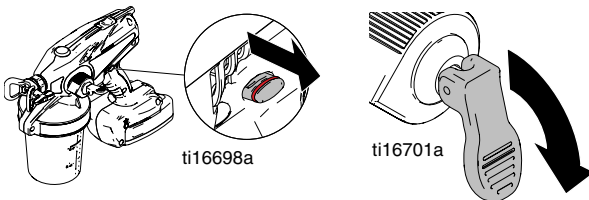

4. Engage trigger lock. Put prime/pressure relief valve UP to release pressure and rotate spray tip back to SPRAY position.

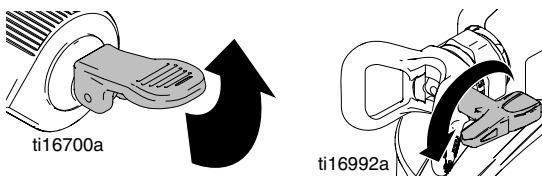

5. Disengage trigger lock, put prime/pressure relief valve DOWN to spray position, and resume spraying.

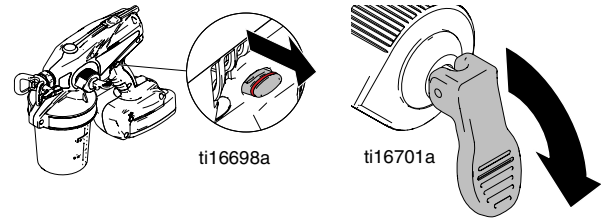

6. If tip is still clogged, you may have to repeat steps 1 - 5 and rotate the tip from SPRAY to UNCLOG several times. Repeat step 1 to release pressure, remove and clean filter, or replace with new tip assembly.

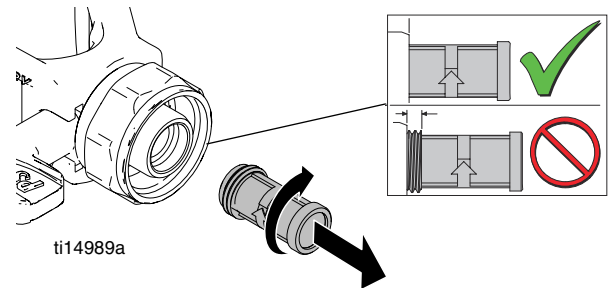

NOTE: Filter assembly is reverse-threaded:
Turn left (or counter-clockwise) to install.
Turn right (or clockwise) to remove.

NOTICE
 Make sure filter is completely screwed into the Tip/Guard Assembly to avoid damage to the filter. Do not use a damaged filter or poor sprayer performance may result.

7. When obstruction is cleared, engage trigger lock and rotate arrow-shaped handle back to SPRAY position.

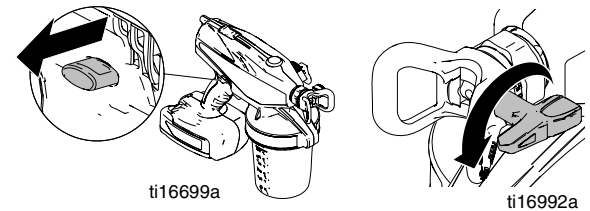

Shutdown and Cleaning

NOTICE

Failure to properly clean sprayer after each use will result in hardened materials, damage to the sprayer, and the warranty will no longer be valid. Do not store solvents other than mineral spirits in sprayer. Always flush with Graco pump armor prior to storage.

Flushing Sprayer



Do not spray solvents through the spray tip. Clean the tip in a bucket of compatible solvent.

Keep spray area well-ventilated. Keep a good supply of fresh air moving through the area.

NOTICE

Protect the internal parts of this sprayer from water. Do not submerge the sprayer in cleaning fluid. Openings in shroud allow cooling of mechanical parts and electronics inside. If water or cleaning fluid gets into these openings, the sprayer could malfunction or become permanently damaged.

1. Engage trigger lock and pull prime/pressure relief valve UP to release pressure.

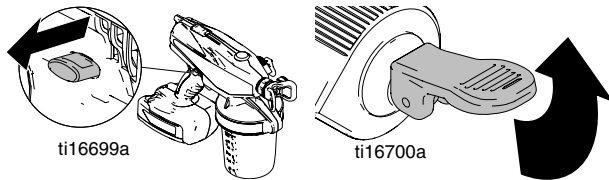

2. Remove material cup and return excess material to proper container. If used, properly dispose the cup liner.

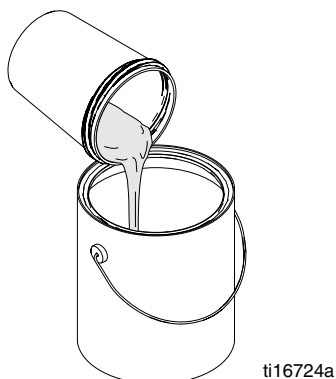

3. Remove and clean sprayer intake tube and screen with water (or flushing fluid) and a brush every time you flush the sprayer. Reconnect intake tube.

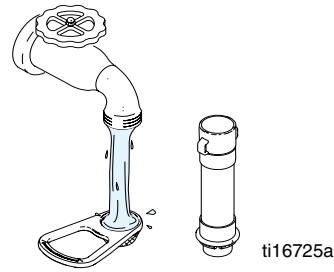

4. Clean cup if not using a liner, and fill with water or appropriate flushing fluid.

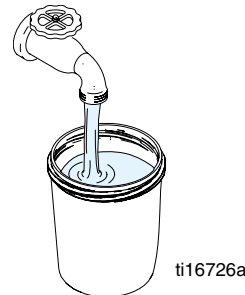

5. Reconnect material cup and shake sprayer to move clean water around and clean all areas inside of cup.

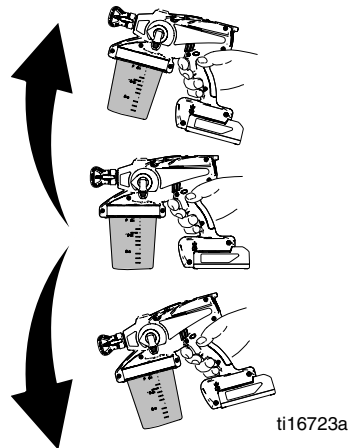

6. Disconnect trigger lock and trigger sprayer for approximately 15 seconds. Engage trigger lock.

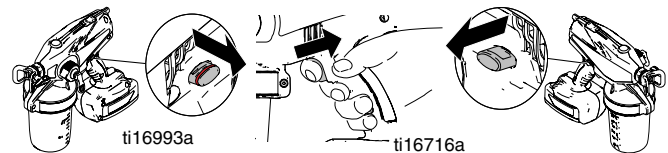

7. Discard contaminated fluid and refill with appropriate flushing fluid.

Shutdown and Cleaning

8. Disengage trigger lock, reverse tip to UNCLOG position, and pull trigger for 5 seconds to prime sprayer.

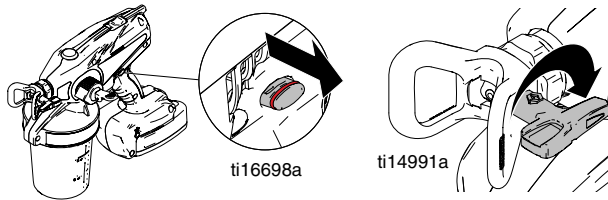

9. Put prime/pressure relief valve DOWN to spray position. Trigger sprayer into waste area until no paint appears in water or flushing fluid.

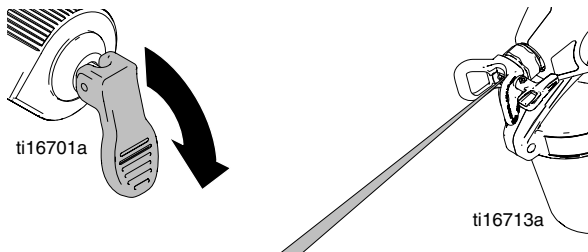

10. If sprayer is not completely clean, repeat steps 4-9.

<p>To avoid serious injury or damage to equipment, do not expose the sprayer electronics to flushing solvents. Keep sprayer at least 10 in. above the rim of the container when flushing.</p>	
<p>Keep spray area well-ventilated. Keep a good supply of fresh air moving through the area. When flushing with solvents, always ground the sprayer and waste container.</p>	

11. Engage trigger lock and put prime/pressure relief valve UP to release pressure.

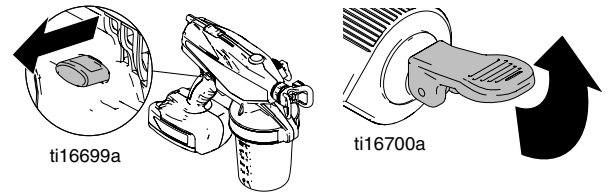

12. Remove material cup and discard used fluid.
13. Use a stiff wire such as a paper clip to make sure vent hole is open.

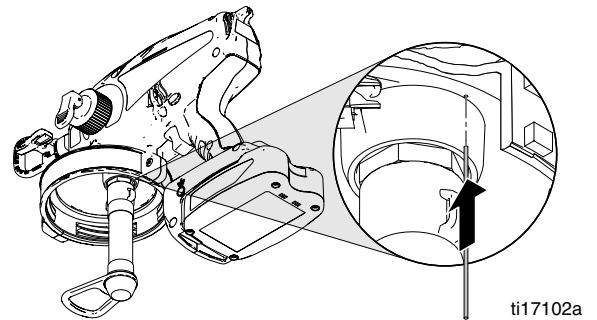

14. Remove Spray Tip/Guard Assembly and clean with water or flushing fluid. A soft brush can be used to loosen and remove dried material if needed.

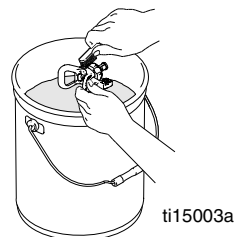

NOTICE
<p>The tip is permanently attached to the guard. Removing the tip from the guard will result in damage to the tip assembly.</p> <p>Do not store tip/guard assembly or suction tube in solvent other than mineral spirits. Damage to parts may occur.</p>

Cleaning Sprayer Exterior

- Wipe paint off outside of sprayer using a soft cloth moistened with water or flushing fluid. Do NOT submerge the sprayer.



ti16728a

<p>This sprayer is equipped with a static wick that reduces the build-up of static charge to reduce the risk of fire and explosion. KEEP THIS SURFACE CLEAN OF OVER-SPRAY.</p>		
		ti16951a

Fine Finish Tip Wear

- Fine Finish Tip/Guard assembly may require replacement depending on abrasiveness of paint.
- Do not spray with worn tip. See **Troubleshooting**, page 26.

Storage



NOTICE

Failure to store sprayer with Pump Armor will result in operational problems the next time you spray. Always circulate Pump Armor through the sprayer after cleaning. **Water or solvents other than mineral spirits left in the sprayer will corrode and damage the pump.**

- Dilute 4 oz. bottle of Pump Armor Concentrate with an additional 4 oz. of water in material cup.

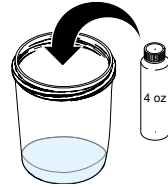

ti16729a

- Thread cup into sprayer, put prime/pressure relief valve to UP position and squeeze sprayer trigger for approximately 10 seconds.

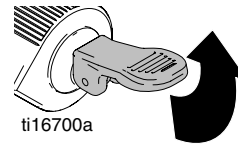

ti16700a

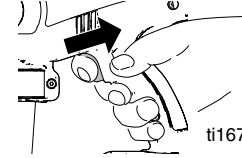

ti16716a

- Reverse spray tip to UNCLOG position, put prime/pressure relief valve DOWN to spray position, and aim sprayer into waste area. Pull trigger for 1-2 seconds.

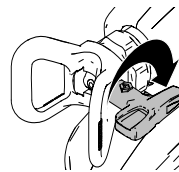

ti14991a

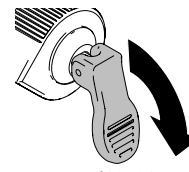

ti16701a

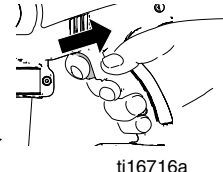

ti16716a

- Properly dispose of used Pump Armor mixture from material cup and rinse cup with water.



ti16726a

- Recharge battery to full charge before storage. See **Charging the Battery**, page 8.
- Store sprayer indoors in a cool, dry place. Store in an **upright position only**. Never store sprayer with material in the cup.

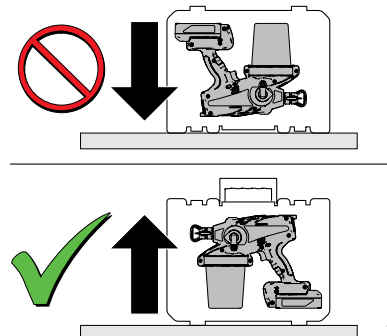

ti16730a

Replacement Parts and Kits

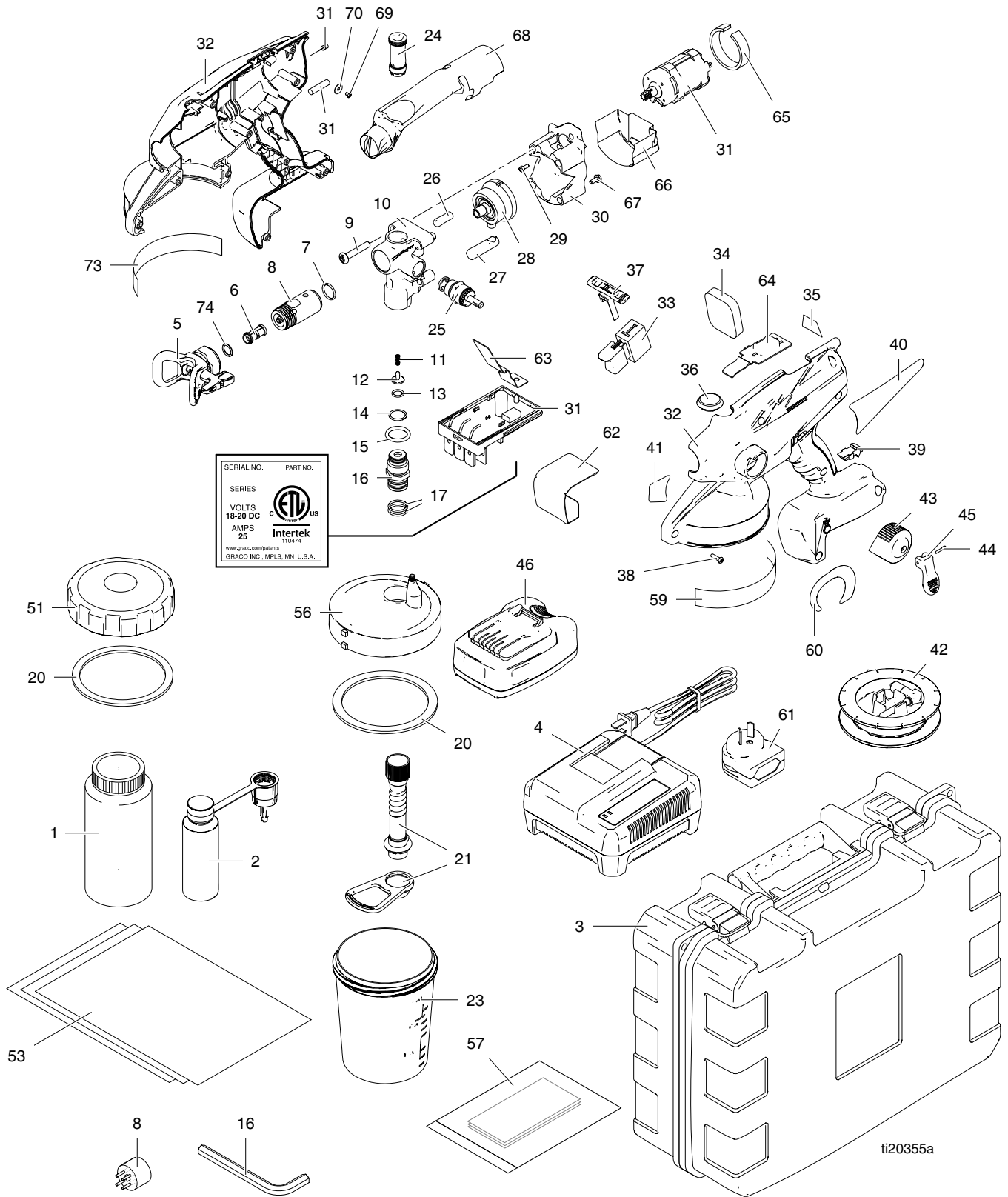

Parts List

Ref.	If you have this model sprayer (model number is the same as the part number, which is below the handle)	Order Part Number:	Description
	Models 16F887, 16H829	24J421	Bare Sprayer (no tip, battery, suction tube, or material cup)
	Model 16H240	24J435	Bare Sprayer (no tip, battery, suction tube, or material cup)
	Models 16H243, 262612	24J555	Bare Sprayer (no tip, battery, suction tube, or material cup)
	Models 16H241, 16H242	24J581	Bare Sprayer (no tip, battery, suction tube, or material cup)
1	All Models	243103	Pump Armor (32oz)
2	Non-Euro Models 16F887, 16H240, 16H242	16M816	Startup/Storage Kit
	Euro Models 16H241, 16H829, 16H243, 262612, 16H245	16P358	Startup/Storage Kit
3	All Models	24J422	Storage Case
4	100-120V Models 16F887, 16H240, 16H242	16D559	Lithium Ion Battery Charger
	230V Models 16H241, 16H829, 16H243, 262612, 16H245	16G615	Lithium Ion Battery Charger
5	All Models	FNS208	208 Fine Finish Spray Tips/Guard Assembly
	All Models	FNS308	308 Fine Finish Spray Tips/Guard Assembly
	All Models	FNS210	210 Fine Finish Spray Tips/Guard Assembly
	All Models	FNS310	310 Fine Finish Spray Tips/Guard Assembly
	All Models	FNS410	410 Fine Finish Spray Tips/Guard Assembly
	All Models	FNS312	312 Fine Finish Spray Tips/Guard Assembly
	All Models	FNS412	412 Fine Finish Spray Tips/Guard Assembly
6	All Models	24E376	Tip Filter Kit, 1-pack, 60 mesh
	All Models	24F039	Tip Filter Kit, 3-pack, 60 mesh
	All Models	24F640	Tip Filter Kit, 1-pack, 100 mesh
	All Models	24F641	Tip Filter Kit, 1-pack, 60 mesh
7	All Models	16H933	Packing, O-Ring (included in 8)
8	All Models	24J433	Kit, repair, needle assembly (includes 7 and wrench)
9	All Models	115478	Screw (included in 30)
10	All Models	16U235	Complete Pump Assembly (includes 11-17, 24-28, 44, 62, 63, 65, 66, 68-70)
	All Models	16U237	Pump Housing only (includes 26, 27, 44, 62, 63, 65, 66, 68-70)
11	All Models	24J424	Inlet Valve Repair Kit (includes 11, 12, 13) (included in 16)
12	All Models	24J424	Inlet Valve Repair Kit (includes 11, 12, 13) (included in 16)
13	All Models	24J424	Inlet Valve Repair Kit (includes 11, 12, 13) (included in 16)
14	All Models	124582	O-Ring (included in 16)
15	All Models	119790	O-Ring (included in 16)
16	All Models	16H641	Pump Valve Repair Kit (includes 11-17, 24 and wrench)
17	All Models	16H934	O-Ring (included in 16, 21)
20	All Models	16J731	Seal, Reservoir (included in 23, 51)
21	All Models	24J423	Tube, suction with strainer inlet (includes 17)
23	All Models	16H618	Material Cup with cover and seal (includes 51)
24	All Models	16H641	Pump Valve Repair Kit (includes 11-17, 24 and wrench)
25	All Models	16H119	Kit, repair, prime / pressure relief valve (includes 43-45)
26	All Models	16U235	Complete Pump Assembly (includes 11-17, 24-28, 44, 62, 63, 65, 66, 68-70)
	All Models	16U237	Pump Housing only (includes 26, 27, 44, 62, 63, 65, 66, 68-70)
27	All Models	16U235	Complete Pump Assembly (includes 11-17, 24-28, 44, 62, 63, 65, 66, 68-70)
	All Models	16U237	Pump Housing only (includes 26, 27, 44, 62, 63, 65, 66, 68-70)
28	All Models	16U236	Kit, reciprocator (includes 38 (qty 10), 44, 62, 63, 65, 66, 68-70)
29	All Models	16G740	Screw (included in 30)
30	All Models	16U239	Kit, repair, drive housing (includes 9, 29, 38 (qty 10), 44, 62, 63, 65-70)
31	All Models	16U234	Kit, repair, motor, control board (includes 29, 34, 38 (qty 10) 44, 62, 63, 65-70)

Table continues on the following page.

Replacement Parts and Kits

Ref.	If you have this model sprayer (model number is the same as the part number, which is below the handle)	Order Part Number:	Description
32	Models 16F887, 16H241, 16H242, 16H829	16U240	Enclosure replacement kit (includes 20, 34-37, 38 (qty 10), 39, 44, 56, 62-66, 68-70)
	Model 16H240	16U241	Enclosure replacement kit (includes 20, 34-37, 38 (qty 10), 39, 44, 56, 62-66, 68-70)
	Models 16H243, 16H245, 262612	16U242	Enclosure replacement kit (includes 20, 34-37, 38 (qty 10), 39, 44, 56, 62-66, 68-70)
33	All Models	16U238	Kit, repair, switch (included in 31)
34	Models 16F887, 16H241, 16H242, 16H829	16U240	Enclosure replacement kit (includes 20, 34-37, 38 (qty 10), 39, 44, 56, 62-66, 68-70)
	Model 16H240	16U241	Enclosure replacement kit (includes 20, 34-37, 38 (qty 10), 39, 44, 56, 62-66, 68-70)
	Models 16H243, 16H245, 262612	16U242	Enclosure replacement kit (includes 20, 34-37, 38 (qty 10), 39, 44, 56, 62-66, 68-70)
35	Models 16F887, 16H241, 16H242, 16H829, 16H240	16E859	Label, Made in USA
	Models 16H243, 16H245, 262612	16F636	Label, Made in USA
36	All Models	16C936	Plug, Service Hole
37	Models 16F887, 16H241, 16H242, 16H829	16U240	Enclosure replacement kit (includes 20, 34-37, 38 (qty 10), 39, 44, 56, 62-66, 68-70)
	Model 16H240	16U241	Enclosure replacement kit (includes 20, 34-37, 38 (qty 10), 39, 44, 56, 62-66, 68-70)
	Models 16H243, 16H245, 262612	16U242	Enclosure replacement kit (includes 20, 34-37, 38 (qty 10), 39, 44, 56, 62-66, 68-70)
38	All Models	119236	Screw
39	Models 16F887, 16H241, 16H242, 16H829	16U240	Enclosure replacement kit (includes 20, 34-37, 38 (qty 10), 39, 44, 56, 62-66, 68-70)
	Model 16H240	16U241	Enclosure replacement kit (includes 20, 34-37, 38 (qty 10), 39, 44, 56, 62-66, 68-70)
	Models 16H243, 16H245, 262612	16U242	Enclosure replacement kit (includes 20, 34-37, 38 (qty 10), 39, 44, 56, 62-66, 68-70)
40	Models 16F887, 16H829	16G644	Label, brand
	Model 16H240	16G645	Label, brand
	Model 16H241, 16H242	16H831	Label, brand
	Model 16H243, 262612	16H816	Label, brand
41	All Models	16G643	Label
42	All Models	16H256	Reel, Ground
43	All Models	16H119	Kit, repair, prime / pressure relief valve (includes 43-45)
44	All Models	16H842	Pin
45	All Models	16H119	Kit, repair, prime / pressure relief valve (includes 43-45)
46	All Models	16G610	Battery
51	All Models	24D425	Kit, lid
53	All Models	16D562	Cup Liner Replacement (10 pack)
56	Models 16F887, 16H241, 16H242, 16H829	16U240	Enclosure replacement kit (includes 20, 34-37, 38 (qty 10), 39, 44, 56, 62-66, 68-70)
	Model 16H240	16U241	Enclosure replacement kit (includes 20, 34-37, 38 (qty 10), 39, 44, 56, 62-66, 68-70)
	Models 16H243, 16H245, 262612	16U242	Enclosure replacement kit (includes 20, 34-37, 38 (qty 10), 39, 44, 56, 62-66, 68-70)
57▲	Models 16F887, 16H240	*24J425	Warning Labels Kit ENG/FRE/SPA
	Models 16H829	*24J518	Warning Labels Kit SPA/POR/ITA Model 16H829
	Models 16H241, 16H242	*24J554	Warning Labels Kit ASIA/ANZ Models 16H241, 16H242
			<i>* Contains all warning labels for the models listed</i>
	Models 16H243, 262612	24J521	Multi-Language Warning Labels Kit, Body
	Models 16H243, 262612	24J519	Multi-Language Warning Labels Kit, Ground Spool
	Models 16H243, 262612	24J520	Multi-Language Warning Labels Kit, Charger
Models 16H243, 262612	24J522	Multi-Language Warning Labels Kit, Battery	
59▲	All Models		Warning Label (included in 24J425)
60	All Models	16G646	Control Label

Ref.	If you have this model sprayer (model number is the same as the part number, which is below the handle)	Order Part Number:	Description
61	Model 16H241 only	124783	Plug Adapter
62-70	Models 16F887, 16H241, 16H242, 16H829	16U240	Enclosure replacement kit (includes 20, 34-37, 38 (qty 10), 39, 44, 56, 62-66, 68-70)
	Model 16H240	16U241	Enclosure replacement kit (includes 20, 34-37, 38 (qty 10), 39, 44, 56, 62-66, 68-70)
	Models 16H243, 16H245, 262612	16U242	Enclosure replacement kit (includes 20, 34-37, 38 (qty 10), 39, 44, 56, 62-66, 68-70)
73▲	All Models		Warning Label (included in 24J425)
74	All Models	16H137	O-Ring (included in 5)
▲ Replacement Danger and Warning Labels, Tags and Cards are available at no cost.			

Alternate Priming Method



If sprayer fails to prime, the inlet valve may be stuck due to paint residue. Perform the steps below.

1. Engage trigger lock and pull prime/pressure relief valve UP to release pressure.

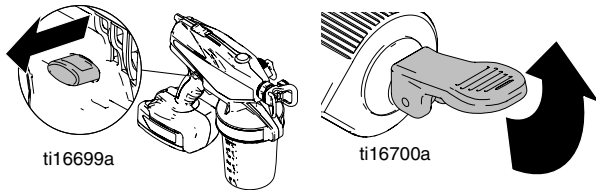

2. Remove material cup and suction tube.

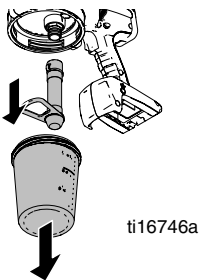

3. Use a pencil or thin rod to lightly push on inlet valve to make sure it moves up and down freely.

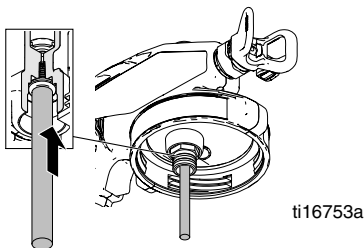

4. If inlet valve does not move freely, perform **Inlet Valve Removal**, page 24. If inlet valve moves freely, install suction tube without strainer, turn sprayer upside-down, and slowly pour flushing material into suction tube until full.

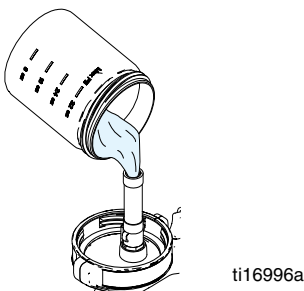

5. Leaving the sprayer upside-down, disengage trigger lock and quickly trigger sprayer until material comes out of drain port.

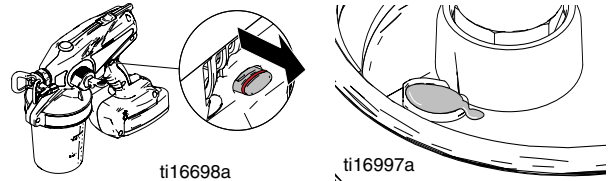

6. Install strainer on suction tube and thread material cup back onto sprayer.

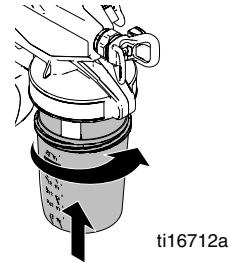

7. Trigger gun for 10 seconds then release trigger and put prime/pressure relief valve DOWN to spray position.

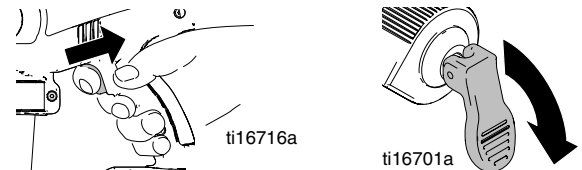

8. Reverse spray tip to UNCLOG position and spray into waste area for five seconds to ensure sprayer has primed.

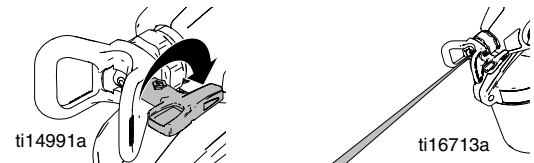

9. Pull prime/pressure relief valve up to release pressure, reverse spray tip to SPRAY position and put prime/pressure relief valve DOWN to spray position. Sprayer is now ready to spray. Perform **Starting New Job** procedure, page 13.



Inlet Valve Removal/Service



1. Engage trigger lock and pull prime/pressure relief valve UP to release pressure.

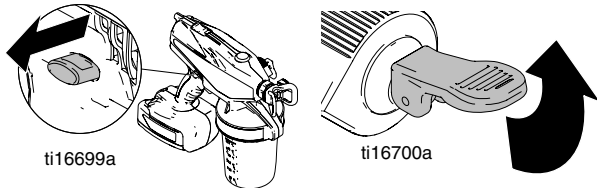

2. Remove material cup, suction tube, and battery.

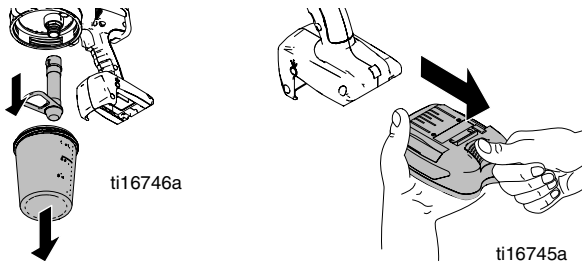

3. Hold sprayer upside-down and use wrench or socket to loosen and remove inlet fitting, inlet valve, and spring.

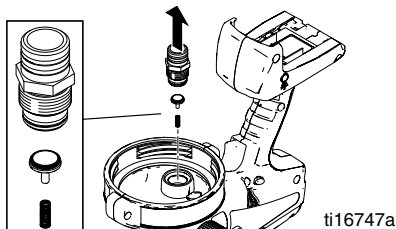

NOTE: Make sure the spring also comes out. Use needle-nose pliers to remove if needed. Inlet cavity should be completely empty (as shown below).

4. Clean as much excess material from inlet cavity as possible. Make sure you also clean spring (a), inlet valve (b), o-ring (c), and top of inlet fitting (d).

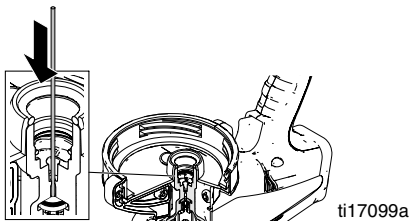

5. Use a thin wire to check that the outlet valve moves freely. If valve does not move freely, perform **Outlet Valve Repair**, page 25.

Installation

NOTE: Before installing, make sure o-ring (c) is installed on inlet valve (b).

1. Place inlet valve (b) with spring (a) on top of inlet fitting (d). Push inlet fitting up into pump cavity.

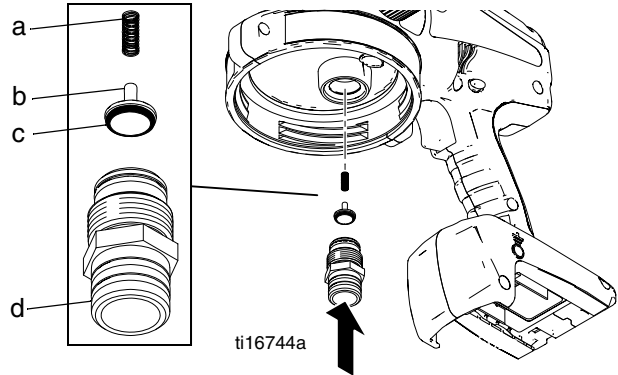

2. Hold inlet in place and turn sprayer upside-down. Remove inlet fitting and visually check to see that inlet valve has seated correctly.

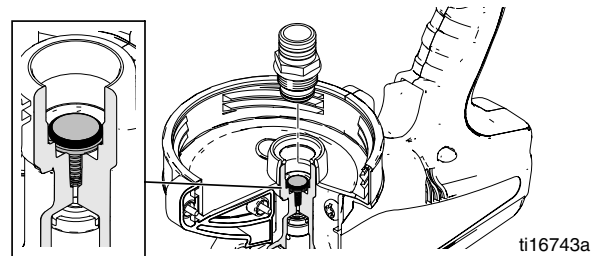

3. Replace inlet fitting and use wrench or socket to tighten to 10 ft-lb.

NOTICE

Do **NOT** over-tighten inlet fitting. Damage to the equipment will occur.

4. Use a pencil or thin rod to lightly push on inlet valve to make sure it moves up and down freely. Perform **Starting New Job** procedure, page 13.

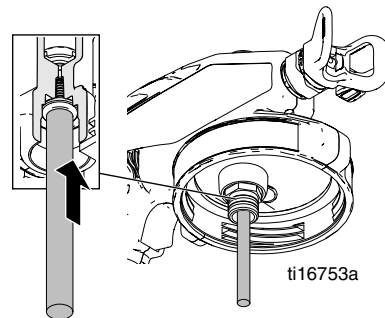

Outlet Valve Repair

				
Move sprayer to a non-hazardous area before servicing.				

NOTE: Before doing any repair to pump, perform **Flushing Sprayer** procedure, page 16.

Removal

1. Engage trigger lock and pull prime/pressure relief valve UP to release pressure.

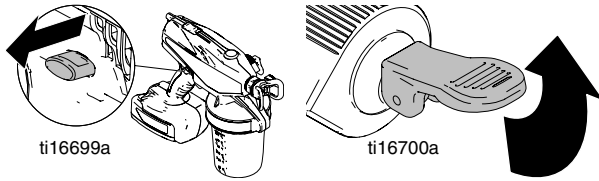

2. Remove battery.

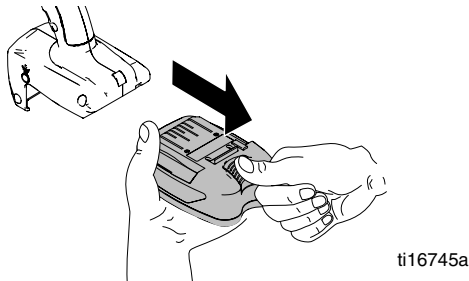

3. Remove pump outlet cap.

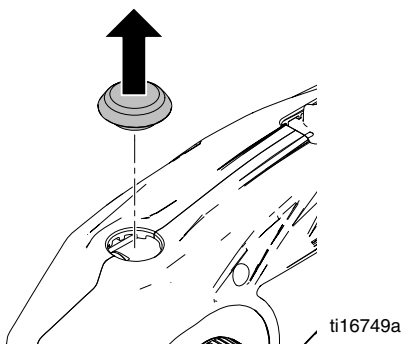

4. Use tool (supplied) to loosen and remove outlet valve fitting. Make sure old o-ring, seat, outlet valve, and spring are out of pump outlet cavity.

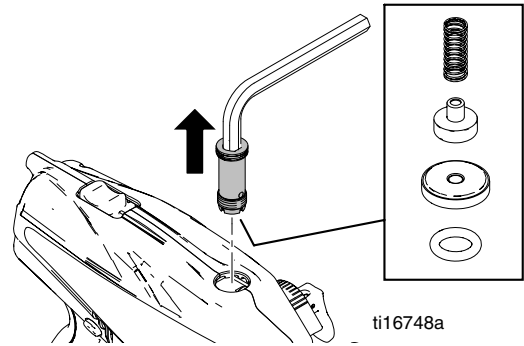

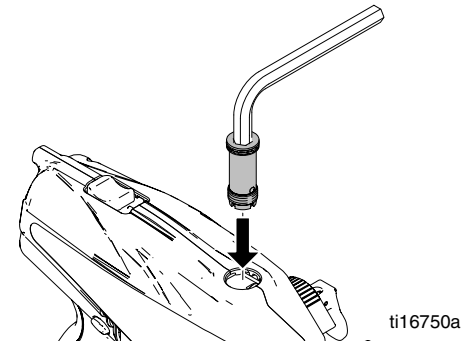

Installation

1. Screw outlet valve fitting into threads. Use tool (supplied) and tighten to 8 ft-lb.

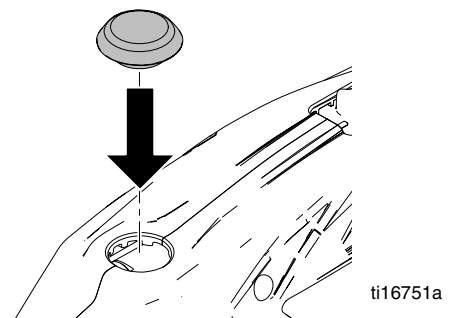

2. Press pump outlet cap into place.



		
Outlet cap prevents the discharge of static electricity. Always replace outlet cap after installing outlet valve.		

Troubleshooting









Check everything in this Troubleshooting Table before you bring the sprayer to an authorized service center.

Problem	Cause	Solution
Sprayer makes no sound when trigger is pulled	Trigger is locked.	Disengage trigger lock. See page 9.
	Status Indicator Light is solid RED when triggering, indicating that the battery charge is low, or the battery is too cold.	Replace with charged battery and place old battery in charger, or allow battery to warm up.
	Status Indicator Light is flashing RED when triggering, indicating that the battery is too hot to operate.	Allow battery to cool.
	Status Indicator Light does not light when sprayer is triggered. Battery is not installed or is damaged.	Install battery or replace.
Sprayer makes sound but no material is sprayed when trigger is pulled	Sprayer is not primed.	Prime the pump. See Starting a new Job (or Refilling the Cup) , page 13. If sprayer fails to prime, follow Alternate Priming Method (page 23).
	Prime/relief valve is in UP position.	Put valve DOWN to spray position.
	Suction Tube is missing or improperly installed.	Make sure Suction Tube is properly installed.
	Suction Tube screen or vent hole is clogged.	See Shutdown and Cleaning , page 16.
	Suction Tube o-rings are damaged or missing.	Replace Suction Tube o-rings.
	Tip is not in SPRAY position.	Turn tip to SPRAY position.
	Tip is clogged.	See Unclogging Tip/Guard Assembly , page 15.
	Tip filter is clogged.	Remove and clean tip filter. See Unclogging Tip/Guard Assembly , page 15.
	Pressure control is too low or Hi/Lo switch is in Lo range.	Turn pressure control up or shift Hi/Lo switch to Hi range.
	Sprayer has been tilted too far and suction tube has lost contact with material.	Make sure cup is filled with material. Rotate suction tube, page 11. Do not tilt the cup too far. Prime the pump. See Starting a new Job (or Refilling the Cup) , page 13.
	No or low material in cup.	Refill cup with material and prime the pump.
	Inlet valve is stuck from material residue left in sprayer.	Use a pencil or thin rod to lightly push on inlet valve to make sure it moves up and down freely. See Inlet Valve Removal/Service , page 24.
	Pump is clogged, frozen, or has debris inside.	See Outlet Valve Repair , page 25 and Inlet Valve Removal/Service , page 24.
Material is leaking from hole in front of sprayer.	Sprayer has reached maximum life. Replace sprayer.	

Problem	Cause	Solution
Sprayer sprays with poor results	Tip is partially clogged	See Unclogging Tip/Guard Assembly , page 15.
	Tip is not in correct position	Rotate tip to SPRAY position.
	Incorrect tip for application of material.	See Reversible Tip Selection Chart , page 13.
	Tip filter is partially clogged or damaged.	Clean or replace filter. See page 15.
	Suction Tube screen is partially clogged.	Clean or replace Suction Tube. See page 16.
	Tip is worn or damaged	Replace tip. See Install Tip/Guard Assembly , page 14.
	Material being sprayed is aerated because it was shaken.	Do NOT shake material. Stir the material or check the manufacturer's recommendation for the material being sprayed.
	Pressure control is too low or Hi/Lo switch is in Lo range	Turn up pressure control or shift Hi/Lo switch to hi range.
	Material being sprayed is too cold to spray.	Warm material.
	Inlet or outlet valves are worn.	See Outlet Valve Repair , page 25 and Inlet Valve Removal/Service , page 24.
Paint leaks from sprayer trigger area.	Sprayer has reached its maximum life.	Replace sprayer.
Battery is discharged but charger still displays green light when battery is inserted.	Damaged battery.	Replace battery.
Battery does not last long.	Battery life varies with material, tip size, pressure, and speed setting.	See Charging the Battery , page 8.

Spray Pattern Diagnostics

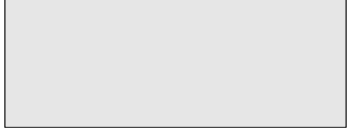
Problem	Cause	Solution
Spray pattern is pulsating: 	Operator is moving too fast while spraying.	Slow speed of movement.
	Hi/Lo switch is in Lo range.	Shift Hi/Lo switch to Hi range.
	Tip or tip filter is clogged.	Unclog tip or clean tip filter, page 15.
Spray pattern has tails:  ti15526a	Pressure control is too low.	Turn up pressure control.
	Incorrect tip for application of material.	See Reversible Tip Selection Chart , page 13.
	Material not compatible with sprayer.	Switch material.
	Inlet or outlet valves are worn.	See Outlet Valve Repair , page 25 and Inlet Valve Removal/Service , page 24.

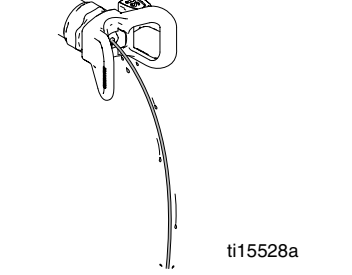
Problem	Cause	Solution
<p>Spray pattern has dripping:</p> 	<p>Sprayer is moving too slow for material.</p> <p>Sprayer is too close to target surface.</p> <p>Holding trigger while changing spray direction.</p> <p>Incorrect tip for application of material.</p> <p>Pressure control is too high or Hi/Lo Switch is in Hi range.</p> <p>Tip is worn or damaged.</p>	<p>Move sprayer faster while spraying.</p> <p>Move sprayer away from surface 10 in. (25 cm)</p> <p>Release trigger when changing directions.</p> <p>See Reversible Tip Selection Chart, page 13.</p> <p>Turn down pressure control or shift Hi/Lo Switch to Lo range.</p> <p>Replace tip. See Install Tip/Guard Assembly, page 14.</p>
<p>Spray pattern is too narrow:</p>  <p>ti15523a</p>	<p>Sprayer is too close to target surface.</p> <p>Incorrect tip for application of material.</p> <p>Tip is worn or damaged.</p>	<p>Move sprayer away from surface 10 in. (25 cm)</p> <p>See Reversible Tip Selection Chart, page 13.</p> <p>Replace tip. See Install Tip/Guard Assembly, page 14.</p>
<p>Spray pattern is too wide:</p>  <p>ti15527a</p>	<p>Sprayer is too far away from target surface.</p> <p>Incorrect tip for application of material.</p>	<p>Move sprayer closer to surface.</p> <p>See Reversible Tip Selection Chart, page 13.</p>
<p>Spray pattern “spits” at the end or beginning:</p>  <p>ti15525a</p>	<p>Excess material has accumulated on Spray Tip/Guard Assembly.</p> <p>Tip filter is partially clogged or damaged.</p> <p>Tip/Guard Assembly not threaded completely onto sprayer.</p> <p>Seat is worn.</p>	<p>See Shutdown and Cleaning, page 16.</p> <p>Clean or replace filter. See page 15.</p> <p>See Install Tip/Guard Assembly, page 14.</p> <p>Replace Spray tip.</p>
<p>Tip continues to drip or ooze material after trigger is released:</p>  <p>ti15528a</p>	<p>Sprayer is worn out.</p> <p>Tip filter is partially clogged or damaged.</p> <p>Tip/Guard Assembly not threaded completely onto sprayer.</p> <p>Seat is worn.</p>	<p>Replace sprayer.</p> <p>Clean or replace filter. See page 15.</p> <p>See Install Tip/Guard Assembly, page 14.</p> <p>Replace Spray tip.</p>
	<p>Needle valve is damaged or worn out.</p>	<p>Replace needle valve.</p>











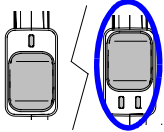

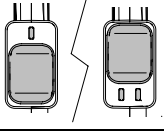

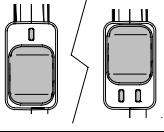

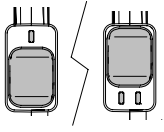

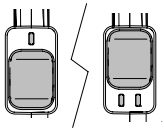
Technical Data

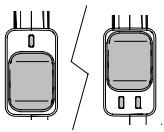
Sprayer:	
Adjustable Pressure Range	500 to 1500 psi (34 to 103 bar, 0.34 to 10.3 MPa)
Maximum working pressure	1700 psi (117 bar, 11.7 MPa)
Weight	5.0 lb (2.25 kg)
Dimensions:	
Length	13.75 in. (34.9 cm)
Width	5.5 in. (14.0 cm)
Height	9.7 in. (24.6 cm)
Storage temperature range ◆❖	32° to 113°F (0° to 45°C)
Operating temperature range ✓	40° to 90° F (4° to 32°C)
Storage Humidity Range	0% to 95% relative humidity, non-condensing
Sound Pressure Level	79.5 dBa† (for sound power level, add 11 dBa)
Vibration Level Acceleration	Less than 8.2 feet/s ² 2.5 m/s ² ††
Charger:	
Charging Time	25 minutes to 80%, 40 minutes to 100%
Power Source	120 VAC
Battery:	
Voltage	18 VDC, Lithium Ion
Capacity	1.2 Ah, 21.6 Wh

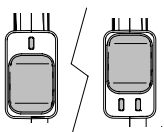
- ◆ Pump damage will occur if fluid freezes in pump.
- ❖ Damage to plastic parts may result if impact occurs in low temperature conditions.
- ✓ Changes in paint viscosity at very low or very high temperatures can affect sprayer performance.
- † per ISO 3744 measured at 3.1 feet (1m)
- †† per ISO 5349, no load condition

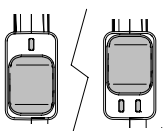
Preferred Material Settings Log

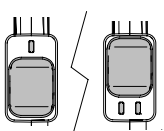
EXAMPLE

Date	Item Sprayed	Material Sprayed	Spray Tip	Motor Speed (Circle One)	Pressure Setting (Mark Dial)
03/24/2011	Crown molding	Urethane varnish	FF308		
					
					
					
					
					
					
					
					

Graco Standard Warranty

Graco warrants all equipment referenced in this document which is manufactured by Graco and bearing its name to be free from defects in material and workmanship on the date of sale to the original purchaser for use. With the exception of any special, extended, or limited warranty published by Graco, Graco will, for a period of twelve months from the date of sale, repair or replace any part of the equipment determined by Graco to be defective. This warranty applies only when the equipment is installed, operated and maintained in accordance with Graco's written recommendations.

This warranty does not cover, and Graco shall not be liable for general wear and tear, or any malfunction, damage or wear caused by faulty installation, misapplication, abrasion, corrosion, inadequate or improper maintenance, negligence, accident, tampering, or substitution of non-Graco component parts. Nor shall Graco be liable for malfunction, damage or wear caused by the incompatibility of Graco equipment with structures, accessories, equipment or materials not supplied by Graco, or the improper design, manufacture, installation, operation or maintenance of structures, accessories, equipment or materials not supplied by Graco.

This warranty is conditioned upon the prepaid return of the equipment claimed to be defective to an authorized Graco distributor for verification of the claimed defect. If the claimed defect is verified, Graco will repair or replace free of charge any defective parts. The equipment will be returned to the original purchaser transportation prepaid. If inspection of the equipment does not disclose any defect in material or workmanship, repairs will be made at a reasonable charge, which charges may include the costs of parts, labor, and transportation.

THIS WARRANTY IS EXCLUSIVE, AND IS IN LIEU OF ANY OTHER WARRANTIES, EXPRESS OR IMPLIED, INCLUDING BUT NOT LIMITED TO WARRANTY OF MERCHANTABILITY OR WARRANTY OF FITNESS FOR A PARTICULAR PURPOSE.

Graco's sole obligation and buyer's sole remedy for any breach of warranty shall be as set forth above. The buyer agrees that no other remedy (including, but not limited to, incidental or consequential damages for lost profits, lost sales, injury to person or property, or any other incidental or consequential loss) shall be available. Any action for breach of warranty must be brought within two (2) years of the date of sale.

GRACO MAKES NO WARRANTY, AND DISCLAIMS ALL IMPLIED WARRANTIES OF MERCHANTABILITY AND FITNESS FOR A PARTICULAR PURPOSE, IN CONNECTION WITH ACCESSORIES, EQUIPMENT, MATERIALS OR COMPONENTS SOLD BUT NOT MANUFACTURED BY GRACO. These items sold, but not manufactured by Graco (such as electric motors, switches, hose, etc.), are subject to the warranty, if any, of their manufacturer. Graco will provide purchaser with reasonable assistance in making any claim for breach of these warranties.

In no event will Graco be liable for indirect, incidental, special or consequential damages resulting from Graco supplying equipment hereunder, or the furnishing, performance, or use of any products or other goods sold hereto, whether due to a breach of contract, breach of warranty, the negligence of Graco, or otherwise.

FOR GRACO CANADA CUSTOMERS

The Parties acknowledge that they have required that the present document, as well as all documents, notices and legal proceedings entered into, given or instituted pursuant hereto or relating directly or indirectly hereto, be drawn up in English. Les parties reconnaissent avoir convenu que la rédaction du présente document sera en Anglais, ainsi que tous documents, avis et procédures judiciaires exécutés, donnés ou intentés, à la suite de ou en rapport, directement ou indirectement, avec les procédures concernées.

Graco Information

For the latest information about Graco products, visit www.graco.com.

TO PLACE AN ORDER, contact your Graco distributor or call to identify the nearest distributor.

Phone: 612-623-6926 **or Toll Free:** 1-800-690-2894 **Fax:** 612-623-6893 **Toll Free Fax:** 1-800-334-6955

*All written and visual data contained in this document reflects the latest product information available at the time of publication.
Graco reserves the right to make changes at any time without notice.*

For patent information, see www.graco.com/patents.
Original instructions. This manual contains English. MM 3A1698

Graco Headquarters: Minneapolis
International Offices: Belgium, China, Japan, Korea

GRACO INC. AND SUBSIDIARIES • P.O. BOX 1441 • MINNEAPOLIS MN 55440-1441 • USA

Copyright 2010, Graco Inc. All Graco manufacturing locations are registered to ISO 9001.

www.graco.com
Revised January 2013